

CONTROL DECK™

THE CONTROL DECK THAT PUTS YOU
IN CONTROL OF INCREDIBLE FUN!



Nintendo

ENTERTAINMENT
SYSTEM®

Nintendo
ENTERTAINMENT
SYSTEM®

NINTENDO OF AMERICA INC.
P.O. BOX 957, REDMOND, WA 98073-0957 U.S.A.

PRINTED IN JAPAN

REV-5

TABLE OF CONTENTS

	Page
CHAPTER I – NES INSTRUCTION MANUAL	1
1. NES Components	2
2. Connecting the NES Control Deck to Your TV Set	3
3. Connecting Your NES Components	7
4. Operating Your NES	8
5. Returning Your TV to Regular Program Viewing	11
6. Care and Precautions	11
7. Troubleshooting	12
CHAPTER II – WARRANTY AND SERVICE INFORMATION	15
1. 90-Day Limited Warranty	16
2. Repair/service after expiration of warranty	18
3. Consumer Parts List and Order Form	19

This official seal is your assurance that Nintendo has reviewed this product and that it has met our standards for excellence in workmanship, reliability and entertainment value. Always look for this seal when buying games and accessories to ensure complete compatibility with your Nintendo Entertainment System.



CHAPTER I

NINTENDO ENTERTAINMENT SYSTEM (NES) INSTRUCTION MANUAL

NEED HELP?
NINTENDO CONSUMER ASSISTANCE TELEPHONE HOTLINE
1-800-255-3700
(MON. to SAT., 4:00A.M. to 10:00P.M., PACIFIC TIME)

PLEASE READ THE SET-UP INSTRUCTIONS CAREFULLY BEFORE ATTEMPTING TO CONNECT THE NES TO YOUR TV SET. IF, AFTER READING ALL SET-UP INSTRUCTIONS, YOU ARE STILL UNABLE TO HOOK UP YOUR SYSTEM, PLEASE CALL OUR CONSUMER SERVICE DEPARTMENT AT THE NUMBER PROVIDED ABOVE.

WARNING

DO NOT USE WITH FRONT OR REAR PROJECTION TV

Do not use a front or rear projection television with your Nintendo Entertainment System[®] ("NES") and NES games. Your projection television screen may be permanently damaged if video games with stationary scenes or patterns are played on your projection television. Similar damage may occur if you place a video game on hold or pause. If you use your projection television with NES games, Nintendo will not be liable for any damage. This situation is not caused by a defect in the NES or NES games; other fixed or repetitive images may cause similar damage to a projection television. Please contact your TV manufacturer for further information.

NINTENDO OF AMERICA INC.

©1990 NINTENDO

1. NES COMPONENTS

• CONTROL DECK

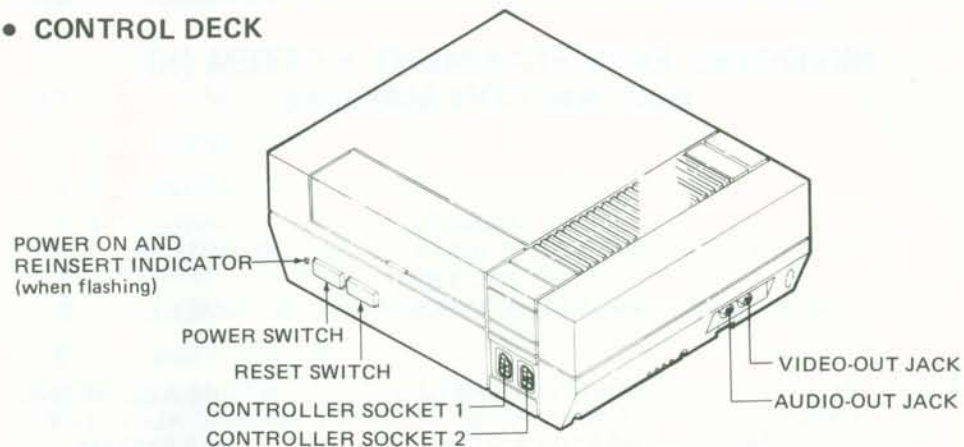

• REAR VIEW OF CONTROL DECK

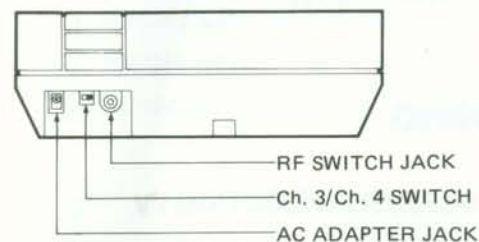

• CONTROLLER

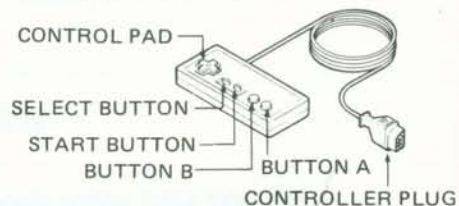

• AC ADAPTER

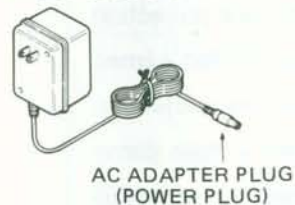

• 75/300Ω CONVERTER



• 300/75Ω CONVERTER



• AUDIO/VIDEO CABLE

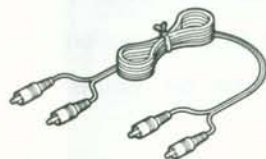

• RF SWITCH

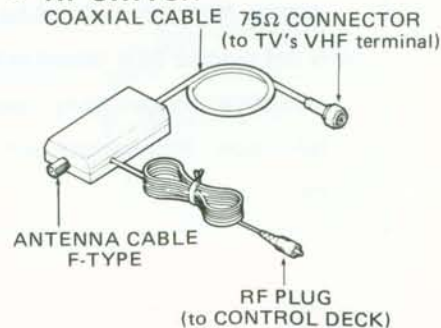

2. CONNECTING THE NES CONTROL DECK TO YOUR TV SET

Please read the set-up instructions carefully before attempting to connect the NES to your TV set. If, after reading all set up instructions, you are still unable to hook up your system, please call our Consumer Service Department at 1-800-422-2602.

There are two alternative methods of connecting the NES Control Deck to your TV set, depending upon your type of TV:

- EITHER: (1) Using the Audio/Video Cable;
 OR: (2) Using the RF Switch and Converters.

Make sure that you are not trying to use both the RF Switch and the Audio/Video Cable; only one is required.

First, compare your TV with the following illustrations (1), (2) (i) and (2) (ii) to determine which method you should use, (1) or (2). If you have a VCR connected to your TV, see Page 6.

(1) Using the Audio/Video Cable

(Note! If your TV does not have direct audio/video connections, proceed directly to Method (2) "using the RF Switch and Converters".)

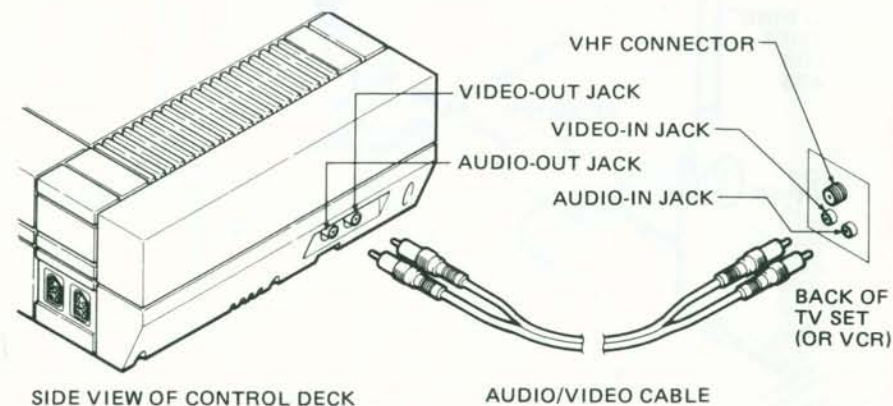

Note! Color coding of TV connections may differ from that of audio/video cable and Control Deck.

To facilitate connection to video recorders, etc., many TV's have special audio/video input jacks. If your TV has such a jack, connect the audio/video cable supplied with the NES between the audio/video-out jacks on the NES Control Deck and the audio/video-in jacks on your TV set, and then flick the switch located on your TV that changes the TV from antenna reception to direct audio/video input. When you use the audio/video cable to connect the NES to your TV, there is no need to use the RF switch or converters, or to touch the antenna on the back of your TV. For more information on direct audio/video hook-ups to your TV, consult your TV Operation Manual.

OR (2) Using the RF Switch and Converters (compatible with most TVs)

- (i) If your TV has **TWO SCREWS FOR (VHF)** antenna connection, connect the RF Switch and NES as shown below. If your TV has a VHF cable connector, please see page 5.

(Note: The existing antenna/cable to the TV should first be disconnected from the TV and then reconnected to the RF Switch. This will allow the signal from the antenna/cable to reach the TV when the NES is turned off.)

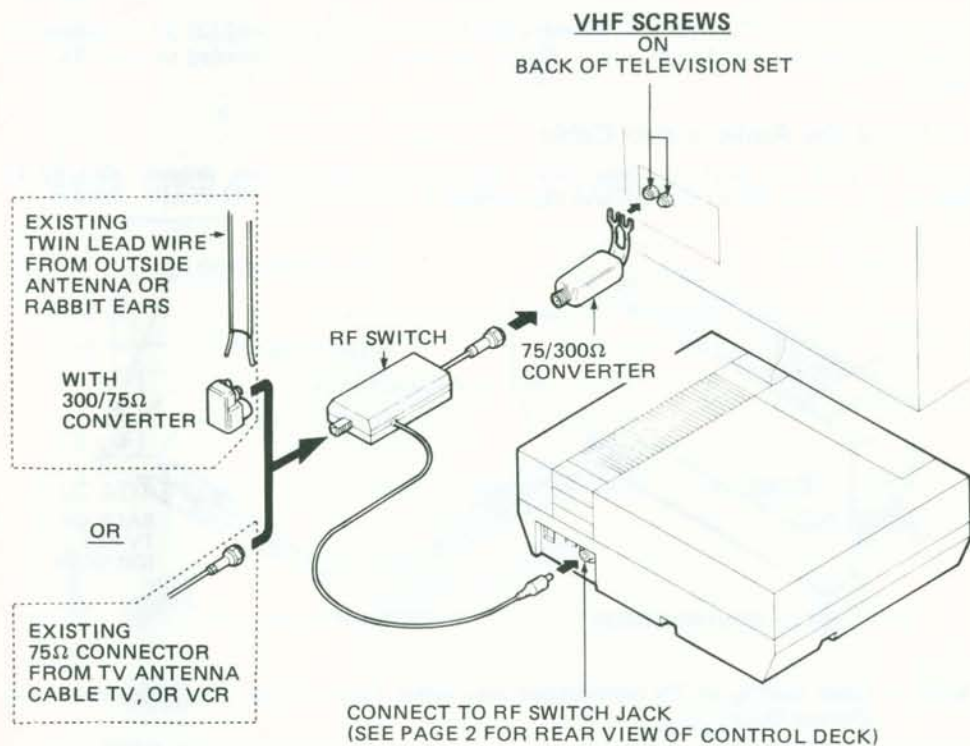

- (ii) If your TV has a **VHF CABLE CONNECTOR** connect the RF switch and NES as shown below.

(Note: The existing antenna/cable to the TV should first be disconnected from the TV and then reconnected to the RF switch. This will allow the signal from the antenna/cable to reach the TV when the NES is turned off.)

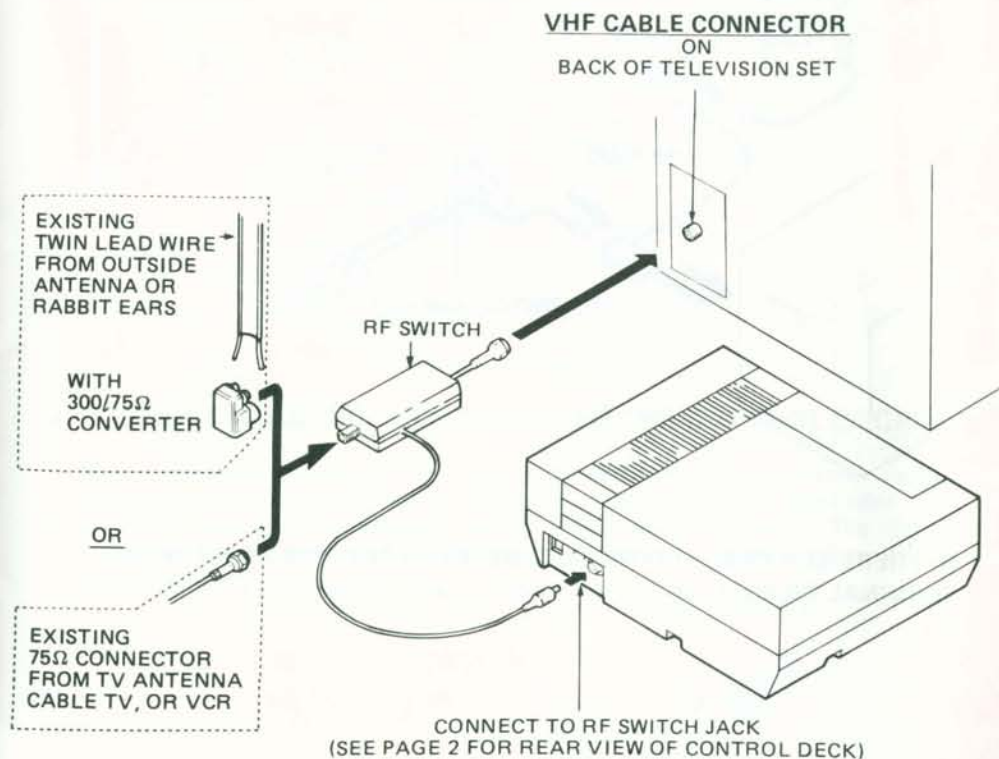

NOTE: If a VCR is already connected between the antenna and the VHF terminals on the back of your TV set, the RF Switch **MUST** be installed **BETWEEN** the VCR and the TV as shown below:
 (Refer to the illustrations on Page 4 and 5 for your type of TV connection.)
 With this hook-up you are still able to record TV programs while using the NES.

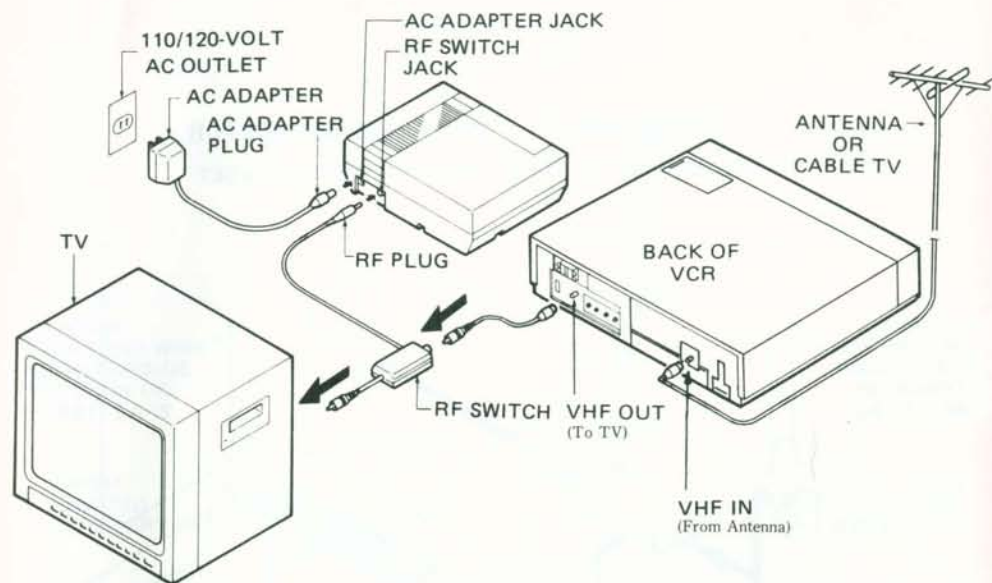

IF THERE IS A CABLE CONNECTED BETWEEN THE VCR AND THE UHF TERMINAL ON BACK OF YOUR TV SET, LEAVE THAT CABLE AS IS.

3. CONNECTING YOUR NES COMPONENTS

• CONNECTING THE AC ADAPTER TO THE CONTROL DECK

Insert the AC adapter power plug into the AC adapter jack on the back of the Control Deck.

Plug the AC adapter into a 110/120-volt AC wall outlet.

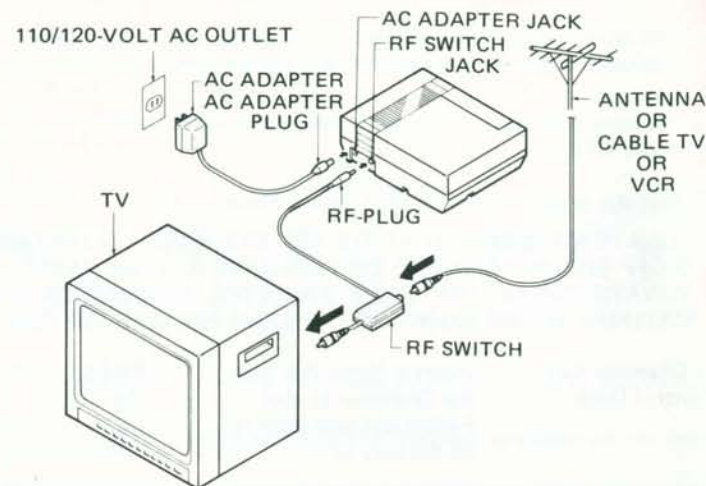

• CONNECTING THE CONTROLLERS TO THE CONTROL DECK

Both controllers are identical and may be connected to either controller socket. However, the controller connected to controller socket 1 becomes Controller 1, and the controller connected to controller socket 2 becomes Controller 2. The distinction is important when selecting and starting games, since only Controller 1 is used to select and start games.

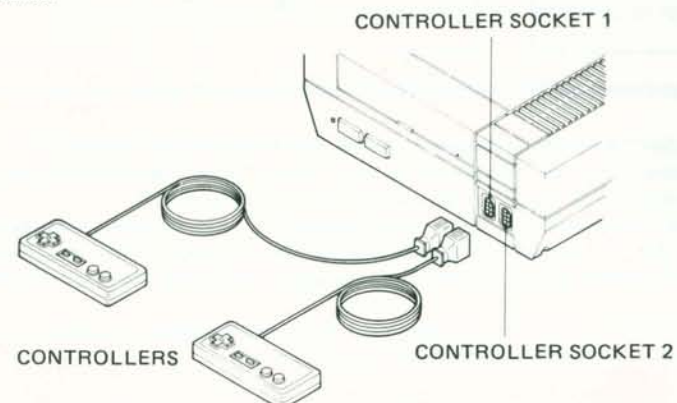

NOTE: Do not insert or remove controllers from control deck during gameplay as this may cause game malfunction.

4. OPERATING YOUR NES

• TO START PLAY

1. Turn your television on to Channel 3.

Note: If Channel 3 is broadcasting in your area and interfering with the game, set the television and the switch on the back of the Control Deck to Channel 4.

2. If your TV has an automatic fine tuning control (AFC), turn it off. (Use the manual fine tune dial to adjust the picture after inserting the game pak as described below).

Note: If you have a color TV that turns black and white when the AFC is turned off, leave the AFC on.

3. Make sure that the power switch on the Control Deck is off.

CAUTION!! ALWAYS MAKE SURE THAT THE POWER SWITCH ON THE CONTROL DECK IS OFF BEFORE INSERTING OR REMOVING A GAME PAK!! ALWAYS CHECK THE GAME PAK EDGE CONNECTOR FOR FOREIGN MATERIAL BEFORE INSERTING THE GAME PAK INTO THE CONTROL DECK!!

4. Open the Chamber Lid on the Control Deck.

Insert a Game Pak into the Chamber (Label Facing up) and Push it all the way in.

PRESS DOWN on the Game Pak until it locks into place and close the Chamber Lid.

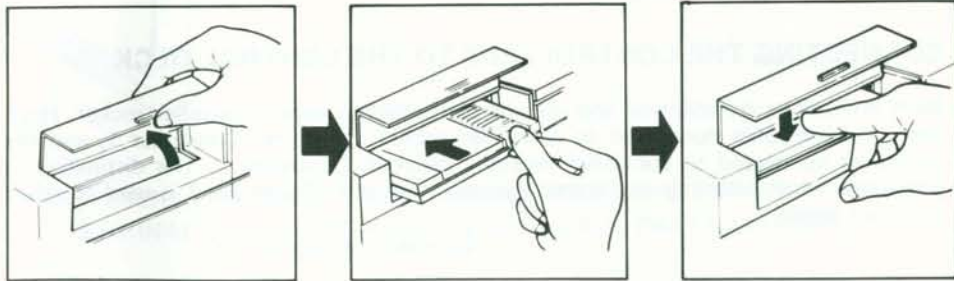

5. Turn on the power switch of the NES Control Deck and push the reset button.

Note: If the "reinsert" indicator light on the front of the Control Deck is flashing, it means that the game pak is not loaded correctly. In this case, turn off the Control Deck power switch and start over from step 4.

Note: When the game pak is inserted properly, a colorful game display should appear on the TV screen. If it does not, or the picture is imperfect, turn the Control Deck power switch off and then on again, and press the reset button.

6. Use the SELECT button on Controller 1 to select the game you want to play, and start the game with the START button on Controller 1.

Note: If you experience any problems in operating your NES, please do not hesitate to call Nintendo's Consumer Service Department, toll free, at 1-800-422-2602.

• CHANGING GAME PAKS

1. Turn off the Control Deck power switch.

CAUTION!! ALWAYS TURN OFF THE CONTROL DECK POWER SWITCH BEFORE INSERTING OR REMOVING A GAME PAK!!

2. Open the Chamber Lid.

Gently push down on the Game Pak allowing it to pop up. Do not attempt to pry the Game Pak up.

Pull the Game Pak out.

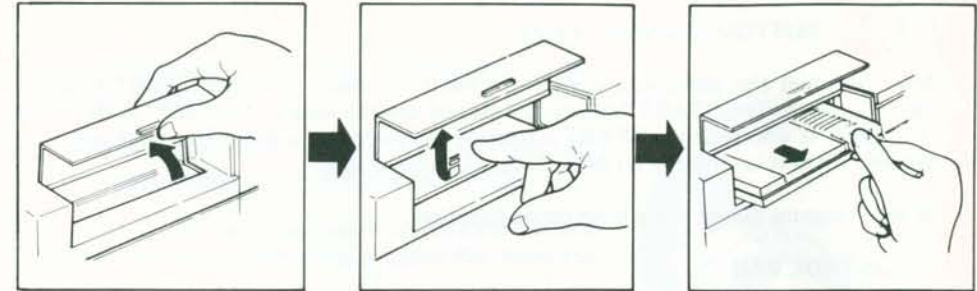

3. Insert a new game pak of your choice into the chamber as shown on the preceding page.

4. Turn on the Control Deck power switch. A colorful game display should appear on the TV screen.

IMPORTANT! After you have finished playing, do not forget to remove the Game Pak from the Control Deck.

Be sure to keep Game Paks and Control Deck chamber clean and free of dirt, dust, lint, etc.

Keep Control Deck cover closed when not inserting or removing Game Paks.

Keep Game Paks stored in their plastic sleeves when not in use.

Do not leave the Control Deck's power on for extended periods when not in use.

• USING THE CONTROLLERS

Your NES includes two identical controllers. The controller you plug into controller socket 1 becomes "Controller 1"; the controller you plug into controller socket 2 becomes "Controller 2". For one player, plug either controller into controller socket 1. For two players, plug both controllers into the controller sockets.

• SELECT BUTTON (Controller 1 only).

Each game pak contains several variations of the game. The SELECT button is used to select the particular variation you want to play from the menu displayed at the beginning of the game.

• START BUTTON (Controller 1 only)

After selecting the game you want from the game menu, push the START button to start the game. The START button can also be used to take a "time-out" in the middle of a game. If you push the START button in the middle of a game, the game will freeze (pause) where it is until the START button is pressed again.

Note: On some games there is no pause function.

• CONTROL PAD

The 4-way Control Pad moves the main character of the game up, down, left, and right; although its function may vary from game to game. Consult the instructions included with your game pak for more details.

• BUTTONS A AND B

Buttons A and B perform different functions in different games. Consult the instructions included with your game pak for details.

NOTE: Do not insert or remove controllers from control deck during gameplay as this may cause game malfunction.

5. RETURNING YOUR TV TO REGULAR PROGRAM VIEWING

After you have finished playing, simply turn off the power switch on the Control Deck, and turn your channel selector to the desired channel to view regular TV programs. (There is no need to disconnect the RF switch, etc.)

6. CARE AND PRECAUTIONS

1. DO NOT USE ANY POWER PLUG OTHER THAN THE AC ADAPTER PROVIDED WITH YOUR NES.
2. Do not use any RF switch other than the one included with your NES.
3. Do not disassemble or attempt to repair the NES components. Doing so voids your warranties.
4. Always turn off the power switch on the Control Deck before inserting or removing a Game Pak from the chamber.
5. Before inserting a Game Pak, always check the Game Pak edge connector and remove any foreign materials. In order to keep the contacts clean, avoid touching the connector with your fingers.
6. After you have finished playing, be sure to remove the Game Pak from the Control Deck and close the chamber cover.
7. Always keep Game Paks stored in their sleeves when not in use.
8. Do not pull or yank the NES wires.
9. Do not store the Control Deck on the floor for long periods where it may collect dirt, dust, lint, etc.
10. Do not drop, bang, or abuse the NES components.
11. Do not leave the Control Deck's power on for extended periods when not in use.
12. When disconnecting the power plug, controller plugs, or the RF plug from the Control Deck, pull from the plug itself - not from the wire.
13. Do not expose the Control Deck, Game Paks, the controllers, the RF switch, or the AC adapter to extreme heat or cold.
14. Do not spill liquids on the Control Deck, Game Paks, controllers, RF switch, AC adapter, etc. To clean, use a soft slightly damp cloth (use water only).



7. TROUBLESHOOTING

SYMPTOM	REMEDY
<ul style="list-style-type: none"> ■ T.V. screen does not come on. 	<ul style="list-style-type: none"> ● Make sure your television set is turned on and the power cord is plugged in.
<ul style="list-style-type: none"> ■ No game playfield image on screen (but screen is lit). 	<ul style="list-style-type: none"> ● Make sure the power switch on the control deck is turned on. ● Make sure that the AC adapter is plugged into a 110/120 volt wall outlet and that the AC adapter output jack is plugged into the Control Deck. ● Make sure that the Control Deck and the antenna wire are connected to the RF switch properly and that the RF switch is connected to the TV (refer to "Connecting the NES Control Deck to Your TV Set"). ● Make sure the game pak is inserted into the control deck correctly (refer to the game pak insertion section in your NES Instruction Manual). Also, try pressing the reset switch on your Control Deck or try turning the power switch off and then turning it on again. ● Make sure that the Channel 3/Channel 4 switch on the Control Deck is set to Channel 3 and that the TV is set to Channel 3.
<ul style="list-style-type: none"> ■ Game playfield is on screen but the picture is rolling or the screen has bars or lines on it. 	<ul style="list-style-type: none"> ● Adjust the vertical or horizontal hold controls on your television until picture becomes steady.
<ul style="list-style-type: none"> ■ Picture quality is good, but sound buzzes or is distorted. 	<ul style="list-style-type: none"> ● If there is interference on Channel 3, change the Channel 3/Channel 4 switch on your Control Deck to Channel 4 and set your TV to Channel 4. ● A particularly strong television station may be broadcasting on Channel 3 or 4 (or on cable TV) in your area and causing interference. Try disconnecting the antenna wire from the RF switch. (You will have to reconnect it again for regular television viewing.) ● Make sure that you are not trying to use both the RF switch and the audio/video cables. Only one or the other is required (see page 3).
<ul style="list-style-type: none"> ■ When not playing your NES, regular T.V. programs will not come in. 	<ul style="list-style-type: none"> ● Make sure the power switch on your Control Deck is turned off. ● Make sure that the antenna is connected to the RF switch properly and that the RF switch is connected to the TV. (Refer to "Connecting the NES Control Deck to Your TV Set".)

(Continued on next page.)

SYMPTOM	REMEDY
<ul style="list-style-type: none"> ■ When not playing your NES, regular T.V. programs will not come in. 	<ul style="list-style-type: none"> ● If regular TV programs will still not come in, unhook your RF switch from your television and hook up the antenna directly. (You will have to hook up the RF switch again in order to play your NES.)
<ul style="list-style-type: none"> ■ Game playfield is on screen, but picture is fuzzy, has no color or has snow in it. 	<ul style="list-style-type: none"> ● Make sure that the Control Deck and the antenna wire are firmly connected to the RF switch and that the RF switch is firmly connected to the TV. (Refer to "Connecting Your NES Control Deck to Your TV Set".) ● Adjust the fine-tune and contrast controls on your TV to receive the clearest picture possible. ● If your TV has an automatic fine-tuning control (AFC), turn it off and use the manual fine-tuning control to get a better picture. (If your TV loses its color when the AFC is off, turn it back on.) ● If the Control Deck is too close to the television, the Control Deck may cause some interference. Try moving the Control Deck farther from the TV. ● If there is interference on Channel 3, change the Channel 3/Channel 4 switch on your control deck to Channel 4 and set your TV to Channel 4. ● A particularly strong television station may be broadcasting on Channel 3 or 4 (or on cable TV) in your area and causing interference. Try disconnecting the antenna wire from the RF switch. (You will have to reconnect it again for regular television viewing.)
<ul style="list-style-type: none"> ■ Picture quality is good, but there are no game sounds. 	<ul style="list-style-type: none"> ● Make sure the TV volume is turned up. ● Adjust fine-tune control until sound is good. ● The sound in some games begins only after the start button is pressed.
<ul style="list-style-type: none"> ■ Picture is blinking or distorted. 	<ul style="list-style-type: none"> ● Try pressing reset button. If no improvement, turn Control Deck power switch off, remove and re-insert pak. Turn power on. Press reset button.

IF YOU ARE STILL UNABLE TO SOLVE THE PROBLEM, PLEASE CALL OUR NES CONSUMER SERVICE DEPARTMENT AT 1-800-255-3700.

COMPLIANCE WITH FCC REGULATIONS

This equipment generates and uses radio frequency energy and if not installed and used properly, that is, in strict accordance with the manufacturer's instructions, may cause interference to radio and television reception. It has been type tested and found to comply with the limits for a Class B computing device in accordance with the specifications in Subpart J of Part 15 of FCC Rules, which are designed to provide reasonable protection against such interference in a residential installation. However, there is no guarantee that interference will not occur in a particular installation. If this equipment does cause interference to radio or television reception, which can be determined by turning the equipment off and on, the user is encouraged to try to correct the interference by one or more of the following measures:

- Reorient the receiving antenna
- Relocate the NES with respect to the receiver
- Move the NES away from the receiver
- Plug the NES into a different outlet so the NES and receiver are on different circuits.

If necessary, the user should consult the dealer or an experienced radio/television technician for additional suggestions. The user may find the following booklet prepared by the Federal Communications Commission helpful:

How to Identify and Resolve Radio-TV Interference Problems. This booklet is available from the U.S. Government Printing Office, Washington, D.C. 20402, Stock No. 004-000-00345-4.

CHAPTER II

WARRANTY AND SERVICE INFORMATION

1. 90-DAY LIMITED WARRANTY

90-DAY LIMITED WARRANTY NINTENDO ENTERTAINMENT SYSTEM

TO VALIDATE THE FOLLOWING 90-DAY LIMITED WARRANTY, YOUR WARRANTY CARD AND SALES SLIP OR PROOF OF PURCHASE, MUST BE COMPLETED AND RETURNED TO NINTENDO WITHIN 10 DAYS AFTER DATE OF PURCHASE.

• 90-DAY LIMITED WARRANTY

Nintendo of America Inc. ("Nintendo") warrants to the original consumer purchaser that this Nintendo Entertainment System "System"* shall be free from defects in material and workmanship for a period of 90 days from the date of purchase. If a defect covered by this warranty occurs during this 90-day warranty period, Nintendo will repair or replace the defective Control Deck or component part, at its option, free of charge.

To receive this warranty service:

1. DO NOT return your defective merchandise to the retailer.
2. Notify the Nintendo Consumer Service Department of the problem requiring warranty service by calling 1-800-255-3700. Our Consumer Service Department is in operation from 4:00A.M. to 10:00P.M. Pacific Time, Monday through Saturday. PLEASE DO NOT send your defective components to Nintendo before calling the Nintendo Consumer Service Department.
3. If the Nintendo Service Representative is unable to solve the problem by phone, he will provide you with a Return Authorization number. You MUST record this number on the outside packaging of your defective components, and return it FREIGHT PREPAID, AND INSURED FOR LOSS OR DAMAGE, TO:

Nintendo of America Inc.
NES Consumer Service Department
4820 – 150th Avenue N.E.
Redmond, WA 98052
RA # _____

This warranty shall not apply if the System has been damaged by negligence, accident, unreasonable use, modification, tampering, or by other causes unrelated to defective materials or workmanship. This warranty shall not apply if the Control Deck serial number has been altered, defaced, or removed.

• WARRANTIES LIMITATIONS

ANY APPLICABLE IMPLIED WARRANTIES, INCLUDING WARRANTIES OF MERCHANTABILITY AND FITNESS FOR A PARTICULAR PURPOSE, ARE HEREBY LIMITED TO NINETY DAYS FROM THE DATE OF PURCHASE AND ARE SUBJECT TO THE CONDITIONS SET FORTH HEREIN. IN NO EVENT SHALL NINTENDO BE LIABLE FOR CONSEQUENTIAL OR INCIDENTAL DAMAGES RESULTING FROM THE BREACH OF ANY EXPRESS OR IMPLIED WARRANTIES.

The provisions of this warranty are valid in the United States only. Some states do not allow limitations on how long an implied warranty lasts or exclusion of consequential or incidental damages, so the above limitation or exclusion may not apply to you. This warranty gives you specific legal rights, and you may also have other rights which vary from state to state.

* Components covered under this warranty are: Nintendo Entertainment System – Control Deck, controllers, AC adapter, RF switch and converters.

2. REPAIR/SERVICE AFTER EXPIRATION OF WARRANTY

If any of your NES System components develop a problem requiring service after the 90-day warranty period, contact the Nintendo Consumer Service Department at 1-800-255-3700. **PLEASE DO NOT** send your defective components to Nintendo before calling the Nintendo Consumer Service Department. If the Nintendo Service Representative is unable to solve the problem over the phone, he may advise you of the approximate cost to repair the component(s) and provide you with a Return Authorization number.

You **MUST** then record this number on the outside packaging of the defective component(s) and return the defective merchandise, FREIGHT PREPAID, AND INSURED FOR LOSS OR DAMAGE TO:

Nintendo of America Inc.
NES Consumer Service Department
4820-150th Avenue N.E.
Redmond, WA 98052
RA # _____

Please enclose a money order payable to Nintendo of America Inc. for the cost quoted you. Repairs may also be charged on a VISA or MASTERCARD credit card. If, after personal inspection, the Nintendo Service Technician determines your NES components cannot be repaired, they will be returned and your payment refunded.

3. CONSUMER PARTS LIST AND ORDER FORM

NINTENDO ENTERTAINMENT SYSTEM PARTS LIST & ORDER FORM

Nintendo Part No.	Part Name	Price	Quantity	Amount of Purchase
202	AC Adapter	\$12.00		
203	RF Switch	11.00		
204	Controller	15.00		
206	300/75Ω Converter	3.00		
207	75/300Ω Converter	3.00		
208	Audio/Video Cable	4.00		
2454	Control Deck Instruction Manual	1.75		
2460	Zapper Instruction Manual	1.75		
6740	Advantage Instruction Manual	1.75		
7374	NES Max Instruction Manual	1.75		
8047	Power Pad Operation Manual	1.75		
316	Game Pak Sleeve	1.00		
5581	Joystick Knob (NES Advantage)	3.00		
5582	Turbo Rate Adjustment Knob	1.00		
6748	3D Glasses (cardboard)	2.00		
6467	Zelda Game Map	1.00		
XXX	Game Pak Manual (please specify)*	1.25		
SUB TOTAL				
WASHINGTON STATE RESIDENTS <u>ONLY</u> ADD 8.1% SALES TAX				
POSTAGE & HANDLING (\$2.00 for orders of \$4.00 or more, 50¢ for orders of less than \$4.00)				
For expedited shipping service (2 day Air Freight) please add an additional \$2.50				
TOTAL AMOUNT DUE				

***PLEASE NOTE:**

Nintendo cannot supply Game Manuals and maps for "Licensed" games. These games can be identified by the words "Licensed By Nintendo for play on the Nintendo Entertainment System" on the packaging. Please contact the Game Licensee (whose name is also on the package) directly for these items. (You may call Nintendo at 1-800-255-3700 for the Licensee's address and telephone number).

FOR ORDERING INSTRUCTIONS PLEASE SEE NEXT PAGE.

To Order By Phone

(Requires VISA or MASTERCARD ONLY; NO C.O.D. Orders)

Call 1-800-255-3700 4:00A.M. to 10:00P.M. Pacific Time (MON. to SAT.)

Please have your VISA or MASTERCARD card number and expiration date ready.

To Order By Mail

1. Please complete the following:

Name _____ Phone () _____

Street Address _____

City _____ State _____ Zip _____

2. Enclose Money Order or Credit Card Authorization for total amount due.

If paying by VISA or MASTERCARD:

Please charge total amount due of \$ _____ to my:

(VISA or MC?) _____ Card No. _____ Expiration Date _____

Name on Card (Print) _____ Signed _____

3. Mail to: Nintendo of America Inc.
4820 150th Avenue N.E.
Redmond, WA 98073-0957

Allow 4 — 6 weeks for delivery. We cannot accept cash, stamps, or C.O.D. orders.
Prices are applicable within the United States only and are subject to change without notice.