



INSTRUCTION MANUAL

**READ ME
FIRST!
HOW TO SET UP AND USE
YOUR GENESIS!**

<http://www.replacementdocs.com>

Television Hookups

If your television hookup looks like this, see page 5.

If your television hookup looks like this, see page 6.

If your television hookup looks like this, see page 7.

If your television hookup looks like this, see page 8.

If your television hookup looks like this, with a VCR attached, see page 9.

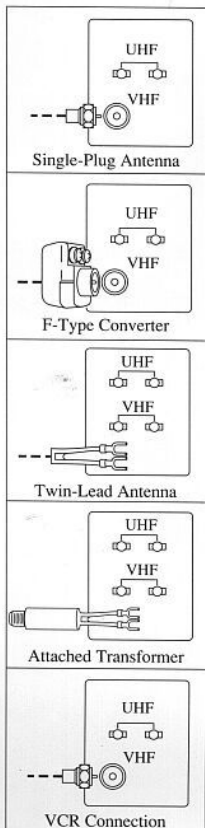

GAME PLAY ASSISTANCE AND INFORMATION

For expert game play assistance or information on other great Sega products, call the Sega experts at:

1-415-871-GAME

IF YOU NEED HELP

Read this manual thoroughly before connecting your Genesis System. If you have difficulties, first consult the Troubleshooting Chart on page 14. For service, call the Sega Consumer Service Department at:

1-800-USA-SEGA

Contents

Parts Identification	3
The Sega Genesis Connection	4
Powering Up the System	11
TV Channel Setting	11
Operating the System	12
Stereo Sound	13
Troubleshooting Chart	14
Limited Warranty	15

Parts Identification

SEGA GENESIS SYSTEM

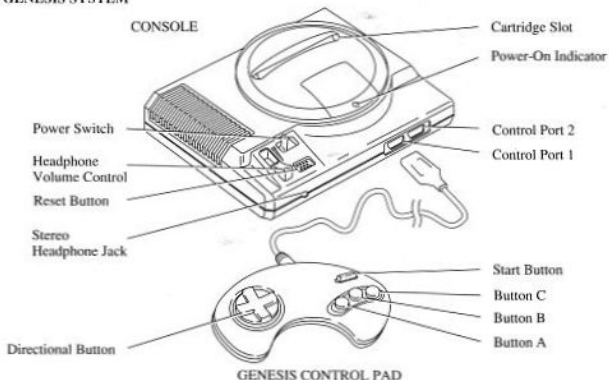

Auto RF Switch Box

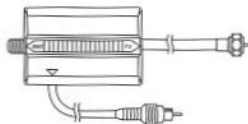

F-type Converter (300/75 ohm)



AC Adaptor



Matching Transformer (75/300 ohm)



Precautions

- ❑ When it's not in use, unplug the AC Adaptor from the electrical outlet.
- ❑ Do not leave the System or any of its parts in direct sunlight, in damp areas or near a heater.
- ❑ Use the Genesis AC Adaptor. Using a different AC Adaptor will damage your System and void the warranty.
- ❑ Do not disassemble the Console or any of its parts.

The Sega Genesis Connection

Hooking Up the Sega Genesis System Is Simple!

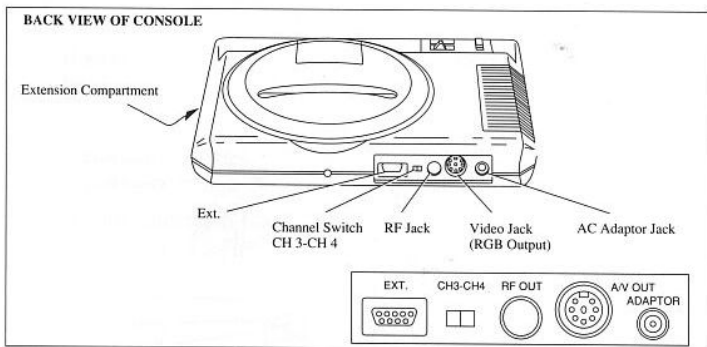

- ❑ The Sega Genesis System comes equipped with RGB analog output for use with a specialized monitor with RGB analog input. For information regarding its use, call Sega Consumer Service at 1-800-USA-SEGA.

Connections to TV/Monitor and Antenna

There are various types of TV sets and antenna terminals. For this reason, we provide *three different types of connectors*:

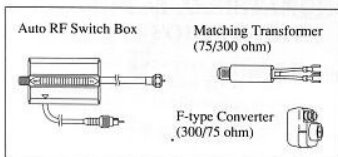

- ❑ The Auto RF Switch Box
- ❑ The F-type Converter (300/75 ohm)
- ❑ The Matching Transformer (75/300 ohm)

You won't need to use all these connectors. Compare your TV to the illustrations on the next few pages to decide which procedure is necessary.

If your TV does not have Video and Audio Inputs, use one of the following procedures:

**TV with single-plug Antenna Cable
(for either Cable TV or VHF Antenna Cable)**

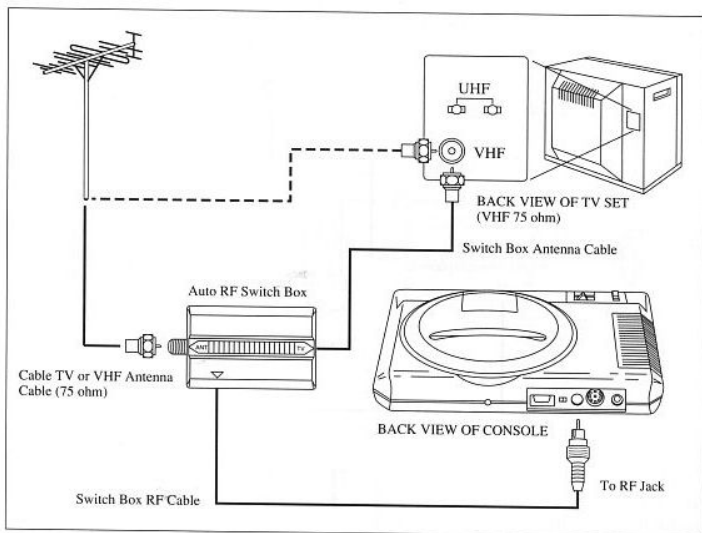

If a single-plug Antenna Cable is plugged into your TV (or if you have Cable TV), use the Auto RF Switch Box. No other connectors are necessary.

1. Unplug the Antenna Cable from the TV, and plug it into the Auto RF Switch Box.
2. Now, plug the Switch Box Antenna Cable into the TV.
3. Finally, plug the Switch Box RF Cable into the RF Jack on the back of the Genesis Console.

TV with F-type Converter

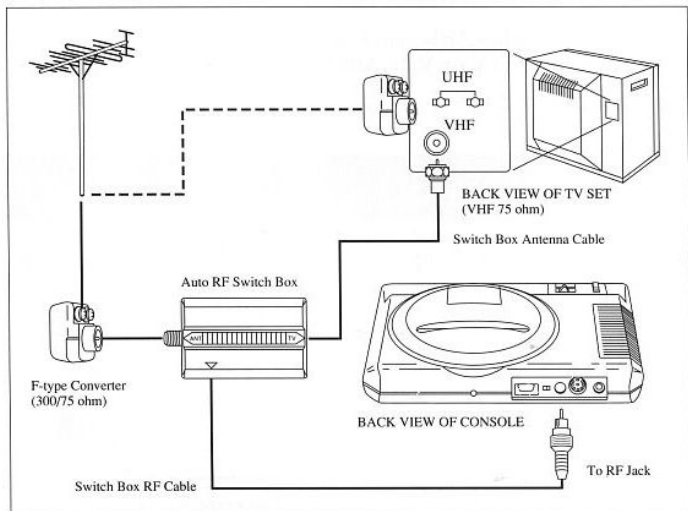

If an F-type Converter is plugged into your TV, use the Auto RF Switch Box. No other connectors are necessary.

1. Find the F-type Converter that's connected to the antenna and plugged into the TV. Unplug it from the TV, and plug it into the Auto RF Switch Box.
2. Now, plug the Switch Box Antenna Cable into the TV.
3. Finally, plug the Switch Box RF Cable into the RF Jack on the back of the Genesis Console.

TV with an Antenna Cable consisting of a Twin-Lead Antenna wire

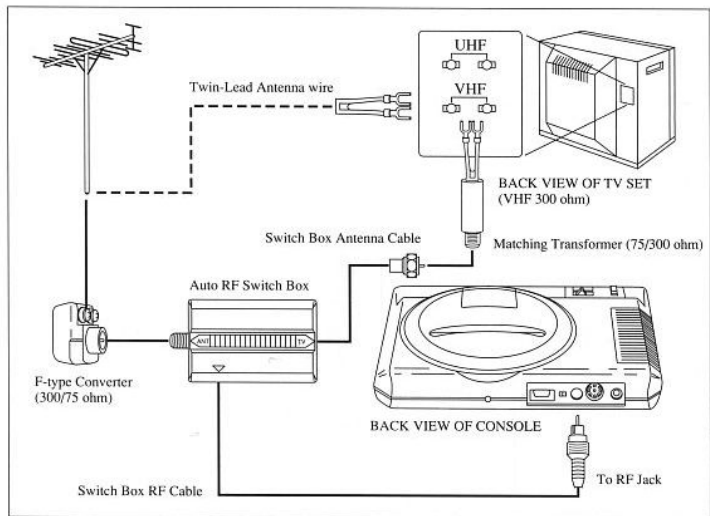

If the Antenna Cable consists of a Twin-Lead Antenna wire connected to your TV, use the Matching Transformer, F-type Converter and Auto RF Switch Box.

1. Disconnect the Twin-Lead Antenna wire from the TV, and connect it to the F-type Converter.
2. Plug the F-type Converter into the Auto RF Switch Box.
3. Plug the Switch Box Antenna Cable into the Matching Transformer. Connect the Transformer's Twin-Lead Antenna wire to the back of the TV.
4. Finally, plug the Switch Box RF Cable into the RF Jack on the back of the Genesis Console.

TV with Cable TV or VHF Antenna Cable plugged into Matching Transformer

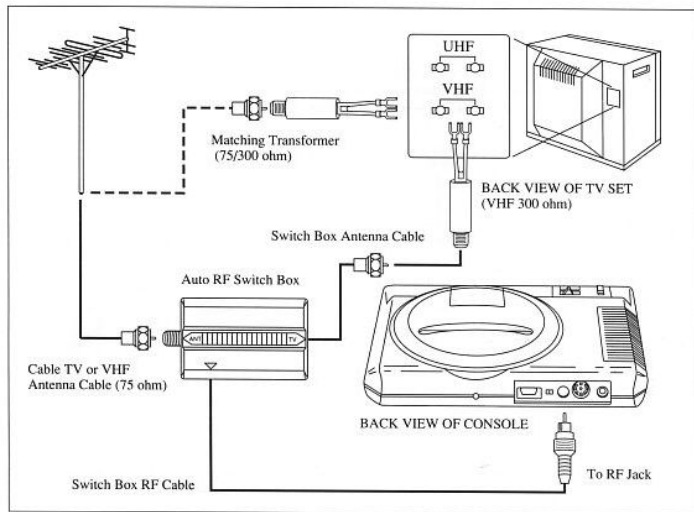

If Cable TV or a VHF Antenna Cable is already plugged into a Matching Transformer on the back of your TV, use the Auto RF Switch Box with the already-present Matching Transformer.

1. Leave the Twin-Lead Antenna wire of the Matching Transformer connected to the TV. Unplug the VHF Antenna Cable from the other end of the Transformer.
2. Plug the VHF Antenna Cable into the Auto RF Switch Box.
3. Plug the Switch Box Antenna Cable into the Matching Transformer.
4. Finally, plug the Switch Box RF Cable into the RF Jack on the back of the Genesis Console.

TV with connected Video Cassette Recorder (VCR)

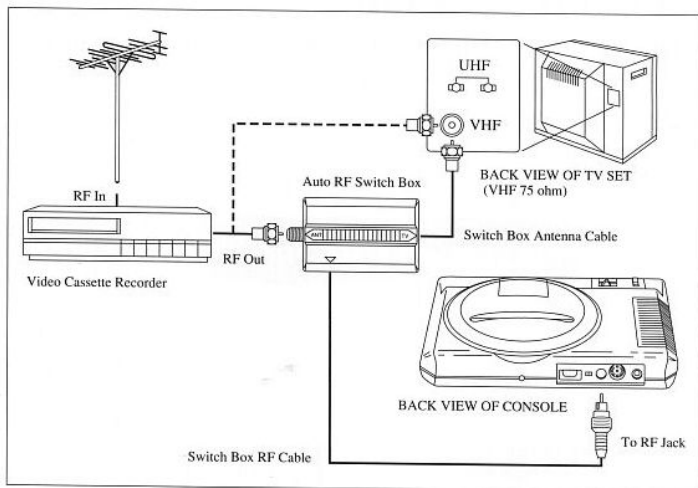

If a Video Cassette Recorder (VCR) is already connected between the antenna and the television's VHF terminals, use the Auto RF Switch Box (and, if necessary, the F-type Converter and/or the Matching Transformer).

1. Disconnect the VCR Cable from the television's VHF terminal (or from its Matching Transformer). Then, plug this same cable into the Auto RF Switch Box. (If this cable has a Twin-Lead Antenna wire, use the F-type Converter to make this connection.)
2. Plug the Switch Box TV Cable into the television's VHF terminal. (If a Twin-Lead Antenna wire is required, use the Matching Transformer to make this connection.)
3. Finally, plug the Switch Box RF Cable into the RF Jack on the back of the Genesis Console.

Optional Hookup

Composite TV or Monitor with Video and Audio Input Jacks

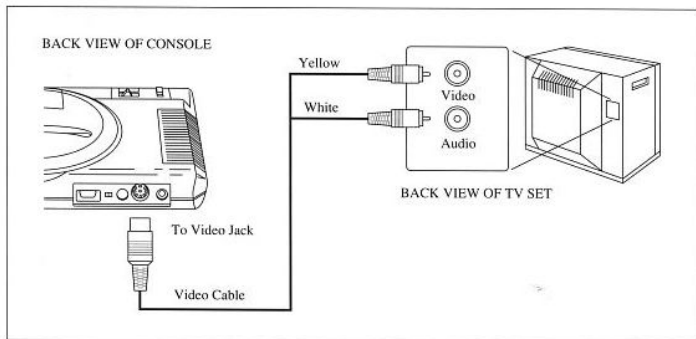

If your composite TV or monitor has Video and Audio Input Jacks (usually on the back of recent models), you can use the *optional* Sega Audio/Video Cable for improved graphics and sound. No other connectors are necessary.

To order the Sega Audio/Video Cable, use the enclosed Parts Order Form, contact your local retailer, or call 1-800-USA-SEGA.

1. Insert the single-plug end of the Audio/Video Cable into the Audio/Video Cable Jack on the Genesis Console.
2. Insert the yellow plug on the Audio/Video Cable into the composite TV or monitor's Video Input Jack. Insert the white plug into the TV or monitor's Audio Input Jack.
3. Lastly, select the Audio/Video Input setting on your composite TV or monitor.

Powering Up the System

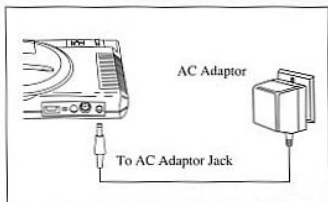

- ❑ Connect the AC Adaptor Plug to the Adaptor Jack on the back of the Genesis Console.
- ❑ Plug the AC Adaptor into an electrical outlet.

TV Channel Setting

BACK VIEW OF CONSOLE

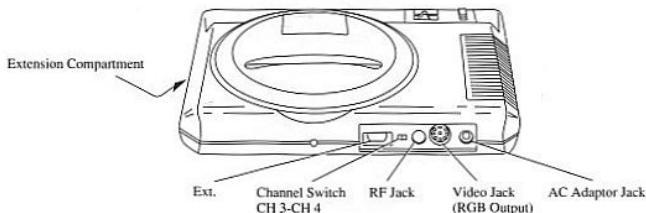

1. Set the Channel Switch on the back of the Power Base to CH 3.
2. Set your TV to channel 3.
3. If channel 3 is used for broadcasting, set your TV to channel 4. Then, switch the Channel Switch on the Power Base to CH 4.
4. If your TV has an automatic fine-tuning control (AFC), turn it off and manually adjust the picture. However, if you have a color TV that turns black and white when the AFC is turned off, leave the AFC on.

Operating the System

SEGA GENESIS SYSTEM

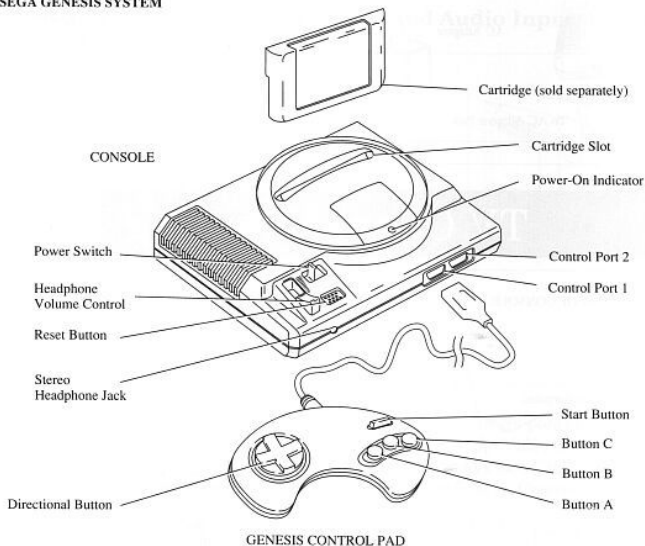

1. Plug a Genesis Control Pad into Control Port 1 on the Console. For two players, plug a second Genesis Control Pad (optional) into Control Port 2.
2. Turn the Power Switch off. Check it by making sure the Power Light is not on.
3. Insert a Cartridge, with the label facing forward, into the Cartridge Slot. Press it **FIRMLY** into the Slot until the Cartridge "locks" into place. (If you turn the Console over, the Cartridge should remain in place.)
4. Turn the Power Switch on. The Power Light should come on.
5. If all connections have been made properly, the Sega logo will appear, followed by the game's Title screen. In some cases, a demonstration game will then begin (see the game's instruction manual).

Stereo Sound

The Genesis System features stereo sound for extra excitement.

To enjoy thrilling stereo game sound effects and music, just plug standard stereo headphones, such as those supplied with a portable cassette player, into the Genesis Headphone Jack.

- ❑ Adjust the headphone volume to a comfortable level.
- ❑ Turn the TV volume all the way down when enjoying stereo sound.
- ❑ Use only stereo headphones with the Genesis System. Attempting to use an earphone (monaural) or similar device might damage it.
- ❑ When you're using the Sega Audio/Video Connector Cable (see page 10), the sound from your TV will be monaural.
- ❑ To hook the Genesis System up to your stereo system, insert a Mini-Y Adaptor into the Genesis Headphone Jack. Insert the left and right inputs into the appropriate input jacks on your stereo receiver. **ALWAYS** have the volume control turned all the way down when you first turn on the Genesis System.

Note: Mini-Y Adaptors are available at your local electronics store or Radio Shack, Model No. 42-2475 and 42-2481.

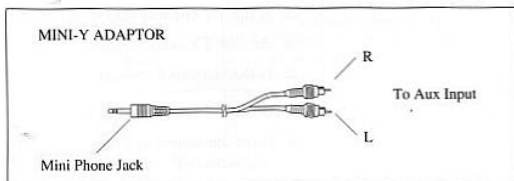

Troubleshooting Chart

The Genesis System

<i>Problem</i>	<i>Before requesting repair, check the following items:</i>
No picture on screen.	<ul style="list-style-type: none"><input type="checkbox"/> Is the Cartridge pushed FIRMLY into the Game Slot?<input type="checkbox"/> Is the Genesis Console turned on?<input type="checkbox"/> Is the AC Adaptor plugged in properly?<input type="checkbox"/> Is the TV turned on?<input type="checkbox"/> Is there power to the wall socket?<input type="checkbox"/> Is the channel switch setting on the back of the Genesis Console the same as the TV channel being used?<input type="checkbox"/> Have you confused the RF Jack with the Video or Power-In Adaptor Jacks?<input type="checkbox"/> Review the connections between the Antenna Cable, Genesis Console, and TV terminals.
Screen flickers or no color.	<ul style="list-style-type: none"><input type="checkbox"/> Are the Antenna Cables connected properly?<input type="checkbox"/> Is the TV channel fine adjustment set properly?<input type="checkbox"/> Are the TV color controls set properly?<input type="checkbox"/> Is the Genesis Cartridge inserted properly?
No game sound.	<ul style="list-style-type: none"><input type="checkbox"/> Is the TV volume too low, or off?<input type="checkbox"/> Have the connection cables come loose, or gotten disconnected?
Picture on TV screen is unsteady.	<ul style="list-style-type: none"><input type="checkbox"/> Adjust the vertical and horizontal hold controls on the TV.
Fringes appear on TV during a game.	<ul style="list-style-type: none"><input type="checkbox"/> Adjust the manual fine tuning adjustment controls on the TV.
Fringes appear on TV during a broadcast.	<ul style="list-style-type: none"><input type="checkbox"/> Is the Antenna Cable connected properly?<input type="checkbox"/> Make sure that you have turned off the Power Switch on the Genesis Console.
No Power Light.	<ul style="list-style-type: none"><input type="checkbox"/> Is there power to the wall socket?
If you continue to have a problem, use this manual to carefully re-connect the system, step by step. If the problem still exists, please call the Sega Consumer Service Department, toll free, at 1-800-USA-SEGA .	

Limited Warranty

Sega of America, Inc. warrants to the original consumer purchaser that the Sega Genesis System and all component parts shall be free from defects in material and workmanship for a period of 90 days from the date of purchase. If a defect covered by this limited warranty occurs during the 90-day limited warranty period, Sega will repair or replace the defective system or component part, at its option, free of charge.

This limited warranty does not apply if the defects have been caused by negligence, accident, unreasonable use, modifications, tampering, or any other causes not related to defective materials or workmanship. Additionally, this warranty shall not be valid if the serial number of the Genesis unit has been altered, defaced or removed in any way.

Please retain your dated sales receipt to easily establish the date of purchase for in-warranty repairs. To receive warranty service, call the Sega Consumer Service Department at:

1-800-USA-SEGA

PLEASE CALL FIRST FOR REPAIR INFORMATION. The cost of returning the system to Sega's Service Center shall be paid by the purchaser.

DO NOT RETURN YOUR SEGA GENESIS SYSTEM TO THE RETAIL SELLER.

Repairs after Expiration of Limited Warranty

If your Sega Genesis System requires repairs after termination of the 90-day limited warranty period, you may contact the Sega Consumer Service Department at the number listed above. If the technician is unable to solve the problem by phone, he or she will advise you of the estimated cost of repair. If you elect to have the repair done, you will need to return the defective merchandise, freight prepaid and insured against loss or damage, to Sega's Service Center with an enclosed check or money order payable to Sega of America, Inc. for the amount of the cost estimate provided to you by the technician. If, after inspection, it is determined that your system cannot be repaired, it will be returned to you and your payment will be refunded.

Limitations on Warranty

Any applicable implied warranties, including warranties of merchantability and fitness for a particular purpose, are hereby limited to 90 days

from the date of purchase and are subject to the conditions set forth herein. In no event shall Sega of America, Inc. be liable for consequential or incidental damages resulting from the breach of any express or implied warranties.

The provisions of this limited warranty are valid in the United States only. Some states do not allow limitations on how long an implied warranty lasts or exclusion of consequential or incidental damages, so the above limitation or exclusion may not apply to you. This limited warranty provides you with specific legal rights. You may have other rights which vary from state to state.

Compliance with FCC Regulations

This equipment generates and uses radio frequency energy and if not installed and used properly, that is, in strict accordance with the manufacturer's instructions, may cause interference to radio and television reception. It has been type-tested and found to comply with the limits for a Class B computing device in accordance with the specifications in Subpart J of Part 15 of FCC Rules, which are designed to provide reasonable protection against such interference in a residential installation. However, there is no guarantee that interference will not occur in a particular installation. If this equipment does cause interference to radio or television reception, which can be determined by turning the equipment off and on, the user is encouraged to try to correct the interference by one or more of the following measures:

- Reorient the receiving antenna.
- Move the Sega Genesis System away from the receiver.
- Plug the Sega Genesis System into a different outlet so that the Sega Genesis System and the receiver are on different branch circuits.

If necessary, the user should consult the dealer or an experienced radio/television technician for additional suggestions. The user may find the following booklet prepared by the Federal Communications Commission helpful: *How to Identify and Resolve Radio-TV Interference Problems*. This booklet is available from the U.S. Government Printing Office, Washington, D.C., 20402, Stock No. 004-000-00345-4.

Warning to owners of projection televisions: Still pictures or images may cause permanent picture-tube damage or mark the phosphor of the CRT. **Avoid repeated or extended use of video games on large-screen projection televisions.**

SEGA

Patents:

U.S. Nos. 4,442,486/4,454,594/4,462,076; Europe No. 80244; Canada No. 1,183,276;
Hong Kong No. 88-4302; Singapore No. 88-155; Japan No. 82-205605 (Pending)

Sega and Genesis are trademarks of Sega Enterprises, Ltd.
© 1991 Sega 130 Shoreline Drive, Redwood City, CA 94065
Printed in Japan <672-0109-01>