

ODYSSEY

ODYSSEY

ODYSSEY

ODYSSEY

ODYSSEY

ODYSSEY™

INSTALLATION AND GAME RULES

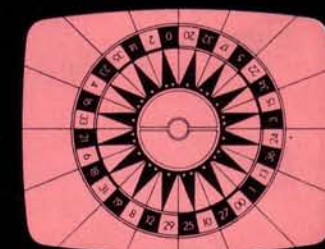
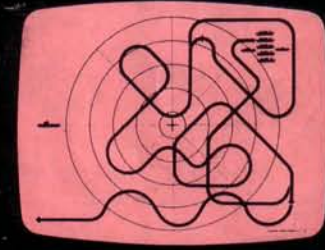
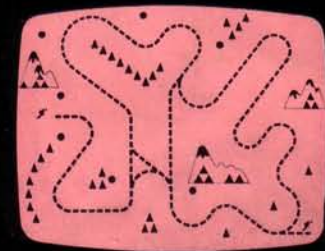
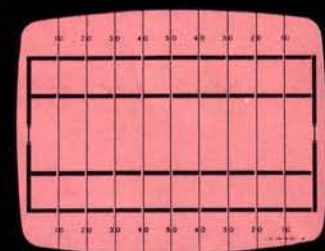
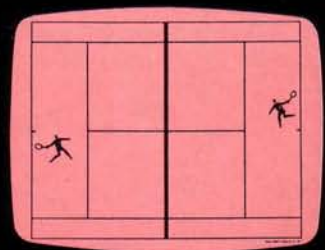

<http://www.replacementdocs.com>

ODYSSEY

A  
Total  
Play  
and  
Learning  
Experience  
For  
All  
Ages

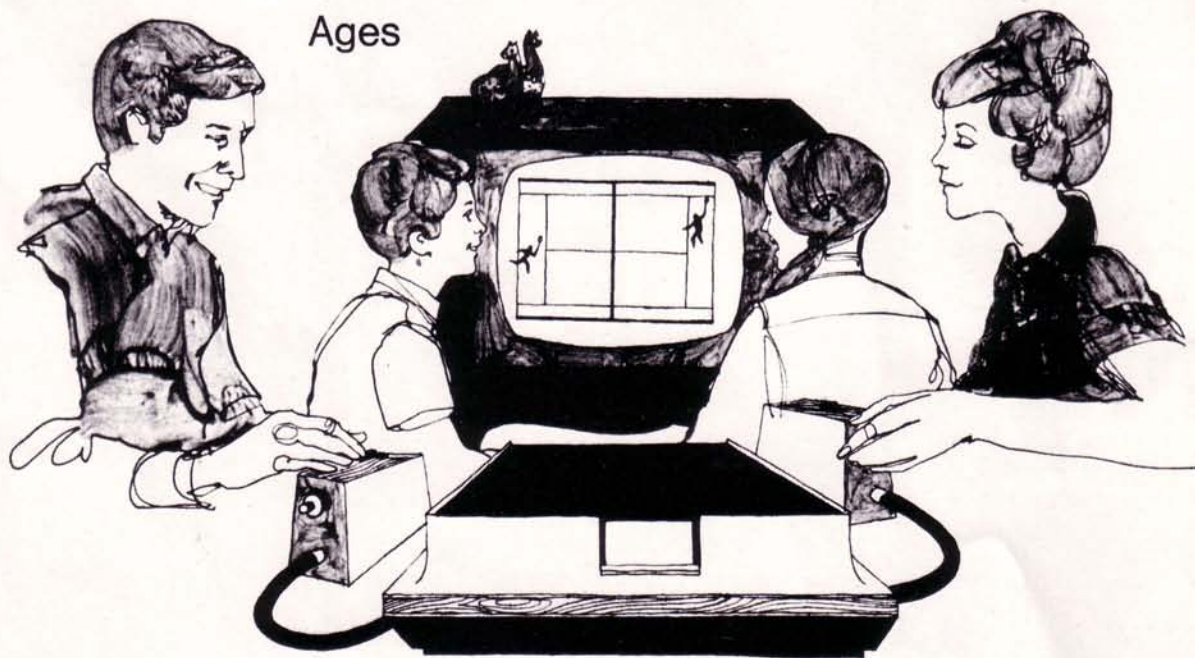



# ODYSSEY—THE ELECTRONIC GAME OF THE FUTURE

ODYSSEY is now yours and your family's to enjoy, to be fascinated by and to learn from. Let us tell you something about it. . . .

ODYSSEY is an electronic game simulator that *easily* attaches to any 18 to 25 inch (diagonal) television—either color or monochrome. (See pages 4-6 to see just how easy it really is!). With ODYSSEY you participate in television, you're not just a spectator! The exciting casino action of Monte Carlo, the thrills of Wimbledon, the challenge of ski trails—can all be duplicated right in your own living room.

ODYSSEY is thought, action and reaction. And, it's an electronic teaching aid, too! It can help your child learn numbers, letters, geography—even abstract thinking! Best of all, ODYSSEY makes learning fun. ODYSSEY is truly a total play and learning experience for the entire family.

ODYSSEY . . . from MAGNAVOX, a leader in the field of quality electronics for over sixty years.

Please carefully read the installation instructions on the following pages to insure complete operating ease. Once you have connected ODYSSEY to your television, we suggest you first play "Table Tennis" (page 10), as it is the basic ODYSSEY game designed to acquaint you with the controls. Have fun!

## TABLE OF CONTENTS

### INSTALLATION INSTRUCTIONS

	Page
Master Control Unit . . . . .	4
Batteries, Channel Switch and the External Power Jack . . . . .	4
Connection of Player Controls . . . . .	4
Connection of Game Cord . . . . .	4
Antenna Game Switch Connection . . . . .	5
Adjusting Television . . . . .	6
Inserting Game Card . . . . .	6
The Player Control Units . . . . .	7
Reset Button . . . . .	7
Horizontal Control . . . . .	7
Vertical Control . . . . .	7
English Control . . . . .	7
Learning to Play . . . . .	8
Overlays . . . . .	9
Caring for your ODYSSEY . . . . .	9

### GAME RULES

	Page
Table Tennis . . . . .	10-11
Tennis . . . . .	11-12
Football . . . . .	13-18
Hockey . . . . .	19-20
Ski . . . . .	21-22
Submarine . . . . .	23
Cat and Mouse . . . . .	24
Haunted House . . . . .	25-26
Analogic . . . . .	27-28
Roulette . . . . .	29-31
States . . . . .	32-33
Simon Says . . . . .	34
Performance Check List . . . . .	35
Additional Games and Game Materials . . . . .	35
Warranty . . . . .	35
Out-of-Warranty Service . . . . .	35



# INSTALLATION

## GETTING TO KNOW YOUR ODYSSEY

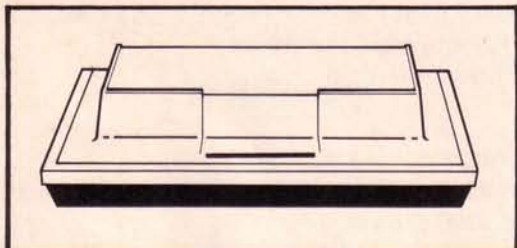

**Your master control unit . . .** is the heart of Odyssey. It contains all the electronics necessary to play the many games provided. It performs much like a television station sending signals to your television receiver.

**Batteries . . .** are used to power your Odyssey. Remove the lid on the battery compartment by sliding the fasteners in the direction the arrows point. Place the six C cell batteries (included with your Odyssey) in the battery holder, as shown.

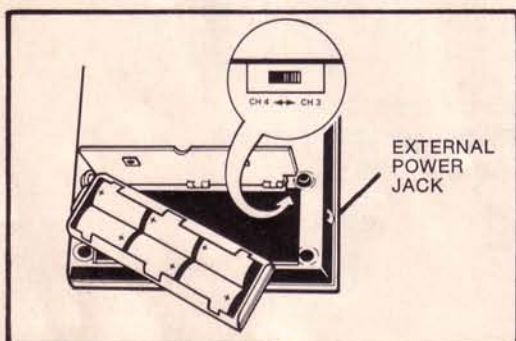

**A channel switch . . .** is provided inside the battery compartment to select either Channel 3 or Channel 4. This switch is normally set at the factory to the Channel 3 position. If a television station is operating on Channel 3 in your area, move the switch to the Channel 4 position. For future reference, indicate here the channel being used for Odyssey: \_\_\_\_\_

**The external power jack . . .** may be used to connect an optional 9-volt external power supply adapter to your unit instead of using batteries. This adapter may be purchased at your local dealer.

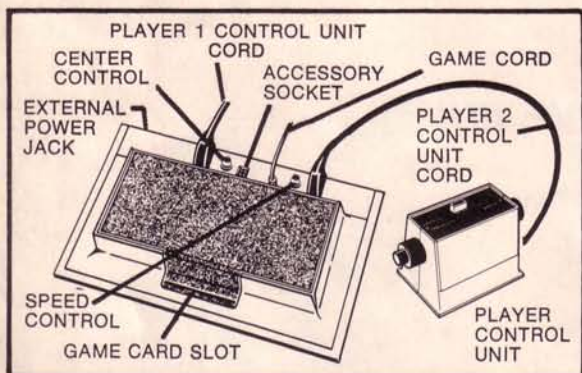

## CONNECTING THE PLAYER CONTROL CABLES AND THE GAME CORD

Plug the Player Control unit cables into the Master Control Unit as illustrated. The two Player Control Units are identical; however, the Player Control Unit connected to the PLAYER 1 socket will be called Player Control Unit Number 1 and the one connected to the PLAYER 2 socket will be called Player Control Unit Number 2.

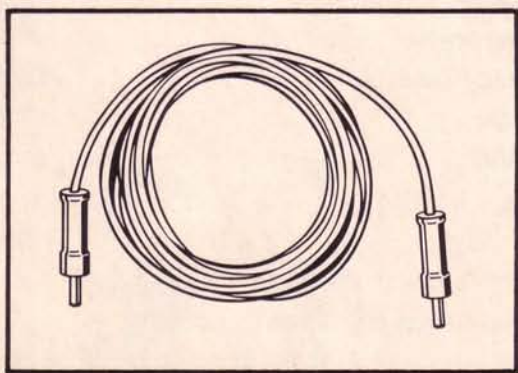

The GAME CORD is used to connect the Master Control Unit to the ANTENNA-GAME SWITCH. Insert one end of the GAME CORD into the socket marked GAME CORD on the Master Control Unit. The other end plugs into the socket on the top of the ANTENNA-GAME SWITCH marked GAME CORD.



## CONNECTING ANTENNA-GAME SWITCH

The ANTENNA-GAME SWITCH is provided as a convenience to allow you to select either Odyssey or regular television viewing, without having to disturb your antenna connections. After its initial installation, you merely move the slide switch to either the GAME position for ODYSSEY . . . or to the TV position for television viewing.

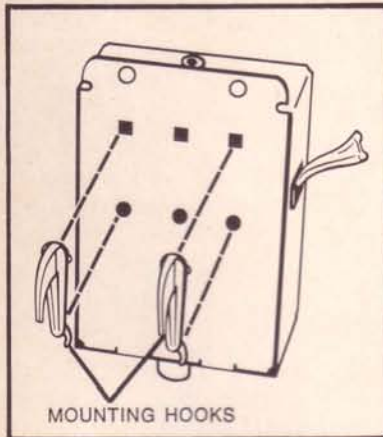
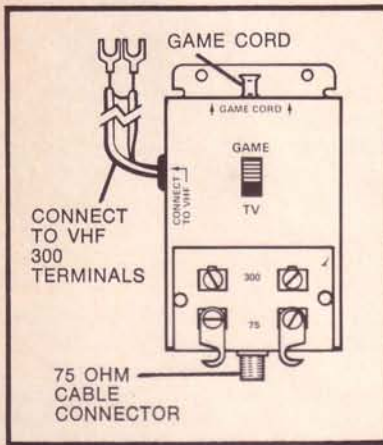

MOUNTING HOOKS are provided for conveniently "hanging" the ANTENNA-GAME SWITCH on the back of your television. Normally only one hook in the center openings of the ANTENNA-GAME SWITCH will be sufficient. After installing the hook, insert the end through one of the ventilating holes on the back of your television near the antenna connections.

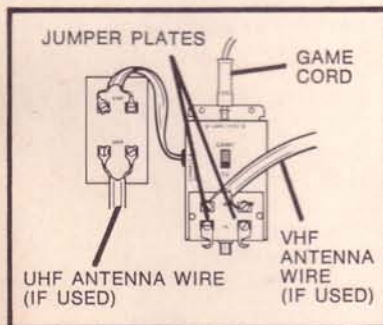

Locate the VHF antenna terminals on the back of your television. Disconnect the VHF antenna cable (if there is one); and connect it to the ANTENNA-GAME SWITCH, as shown in the illustration. Connect the lead from the ANTENNA-GAME SWITCH to the VHF-300 terminals. The ANTENNA-GAME SWITCH is now permanently connected to your television. (When changing from GAME to TV, make certain the slide switch is moved to the extreme position; do not leave it in the middle, as you will not have proper operation.) Additional ANTENNA-GAME SWITCHES may be purchased at your local Magnavox dealer, so you may install one on each television in your home.

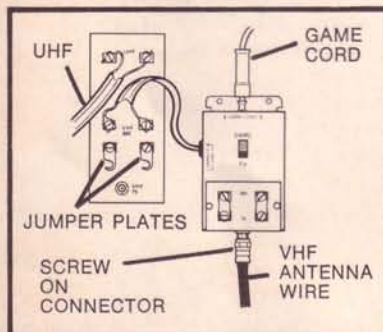

The antenna connections on your television may not be like either of the methods shown. Therefore, follow the procedure outlined on page 6 to connect your ANTENNA-GAME SWITCH.



## IF YOU ARE RECEIVING VHF TELEVISION—CHANNELS 2 thru 13...

1. Locate the antenna terminals on your television.
2. If your VHF antenna cable is the type that is generally flat in shape and has two wires coming out of each side of the end, disconnect the wires from the television and connect them to the two screws marked VHF-300 on the ANTENNA-GAME SWITCH. Be sure the jumper plates are not connected between the lower and upper screws.
3. If your antenna cable is a round cable with a screw-on type connector (75-ohm), unscrew the connector and very *carefully* screw it on the 75-ohm connector on the ANTENNA-GAME SWITCH.
4. If your connector will screw on the ANTENNA-GAME SWITCH, swing the jumper plates on the ANTENNA-GAME SWITCH under the 300 screws and then tighten the screws. Then locate the pair of screws marked VHF-300 on your television and connect the wires from the ANTENNA-GAME SWITCH to the screws on your television. Your television will probably also have a set of jumper plates or a switch that must be moved to allow you to use the VHF-

300 terminals. The instruction booklet for your television may help here.

5. If your connector will not screw on the ANTENNA-GAME SWITCH or is the plug-in type, locate the pair of screws marked VHF-300 on your television and connect the wires from the ANTENNA-GAME SWITCH to these screws. Your television will probably have a set of jumper plates or a switch which must be moved to select the VHF-300 terminals. Your television instruction booklet may help here. If you do not have the jumper plates or switch, it will be necessary to disconnect your VHF antenna cable in order to play ODYSSEY.

Naturally, disconnecting and reconnecting the antenna will be extremely inconvenient as you change from playing ODYSSEY to watching regular television; therefore, we would suggest you contact your television dealer or service company and have them supply you with an adapter to convert your connector to the "F" type connector used on the ODYSSEY ANTENNA-GAME SWITCH.

## IF YOU ARE RECEIVING ONLY UHF Television—CHANNELS 14 thru 83...

1. Locate the antenna connections on the back of your television and find the pair of screws marked VHF or VHF-300.
2. Connect the wires from the ANTENNA-GAME SWITCH to these screws.
3. Some television instruments may also have another connection for a VHF antenna. This connection will be for some type of screw-on or plug-in type connector. If you have this type (75-ohm) connection, you may also have a switch or a set of jumper bars to move before you can use the regular VHF antenna terminal screws. Your instruction booklet for your television may help here.

If the VHF antenna connections on your television are different from those explained here, we suggest you contact your Magnavox dealer for assistance in installing the ANTENNA-GAME SWITCH.

## ADJUSTING YOUR TELEVISION

Before proceeding further, set the ANTENNA-GAME SWITCH to the TV position and turn on your television. Select a known operating channel and adjust your television for normal picture viewing. *If your TV incorporates a Remote System with Automatic Shut-Off, place the Remote Defeat Switch on the television in the "OFF" position.*

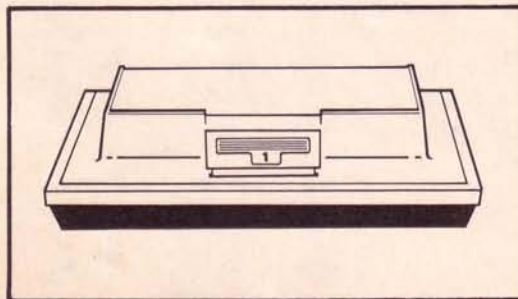
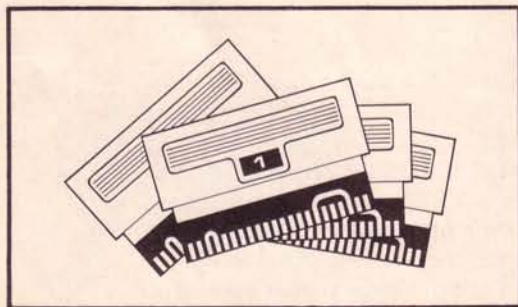

Now, set the television to the VHF Channel (3 or 4) on which the ODYSSEY games will be played (see page 4). Plug the one end of the GAME CORD into the GAME CORD socket on the ANTENNA-GAME SWITCH and place the switch in the GAME position. Insert Game Card No. 1 for "Table Tennis" in the GAME CARD SLOT on the Master Control Unit and press down firmly until it is completely plugged in. The number 1 should be facing outward. The GAME CARD is also the power switch for the Master Control Unit so a signal is now being sent to your television receiver. *It is therefore very important that you remove the GAME CARD after playing, so that battery power is not depleted.*

You will see a white vertical line from the top to bottom and possibly one or two small white squares. Adjust the VHF Fine Tuning on the television, if necessary, until this vertical line is straight and clear. Also, adjust the Brightness and Contrast controls of your television for a bright white line against a dark gray background. (If you do not obtain this white vertical line refer to page 35)



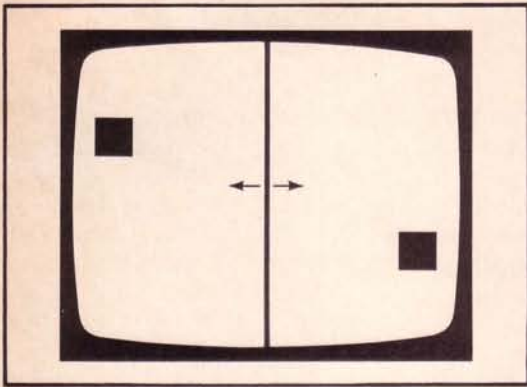

THE CENTER CONTROL ON THE MASTER CONTROL UNIT should be adjusted until the vertical line is in the center of the television screen, as shown at left.

## THE PLAYER CONTROL UNITS

The knobs on the Player Control Units will be used to control the action taking place on your television screen. The illustration below shows the action when Game Card No. 1 is used.

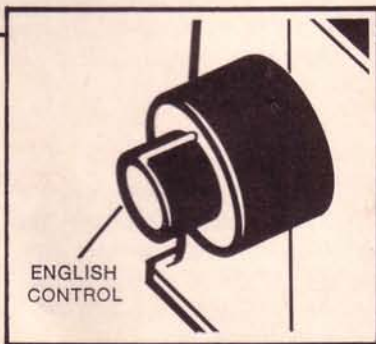
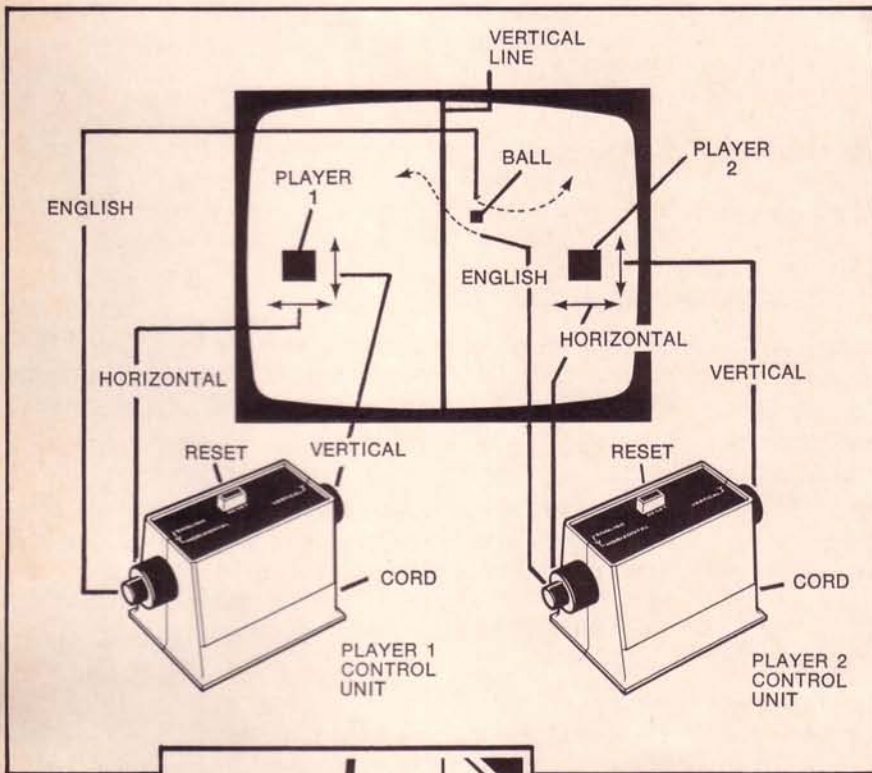

**Vertical.** The Vertical control will always cause a player to move up or down. With the cord on the right side and the Player Control Unit in front of you, turning the knob away from you will cause the Player to move up; and turning the knob toward you will cause the Player to move down.

**Horizontal.** The Horizontal control will always cause a Player to move left or right. With the cord on the right side and the Player Control Unit in front of you, turning the knob away from you will cause the Player to move to the left; and turning the knob toward you will cause the player to move to the right.

**Reset.** Pressing and releasing the Reset button will make the Ball appear on the television screen. If Game Card No. 1 has just been inserted, pressing the Player 2 Reset button should cause the Ball to appear on the screen—moving toward the left. During the game, the Player 1 Reset button will cause the Ball to appear if the Ball disappeared at the left side of the screen, and the Player 2 Reset button will cause the Ball to appear if the Ball disappeared at the right side of the screen. The effect of the Reset buttons will change with some Game Cards. The rules for each game will tell you how to use the Reset buttons.

**English.** The English control affects only the ball. When the ball is travelling from left to right, only the Player 1 English control will affect the ball. When the ball is travelling from right to left, only the Player 2 English control will affect the Ball. The English control will cause the Ball to move upward or downward, depending upon the rotation of the control knob. The further the knob is turned, the more the Ball will deflect. For your ease in determining the approximate centering of this English control, a "raised" marking is provided on the knob. This marking should be in the upright center position of the knob when you return the Ball to the screen.



## LEARNING TO PLAY

The following steps describe the use of all controls. Practice using the controls as described and then turn to the Game Rules section of this booklet to learn how to play the games. Some of the games will not use the controls in this manner but the basic actions will be similar. The Game Rules explain the use of the controls for each game.

1. Remove and then reinsert Game Card No. 1. This will clear the circuit and allow the following steps to be performed in sequence. Game Card No. 1 is the Game Card for Table Tennis, the basic ODYSSEY game.
2. Turn the SPEED control all the way to the left. The game will now be played at the slowest speed. As you become more skillful, turn the SPEED control more to the right to increase the speed of the moving Ball.
3. One person should select the Player 1 Control Unit and another the Player 2 Control Unit. A Control Unit should be in front of each player—with his right hand on the VERTICAL control and his left hand on the ENGLISH control. The person operating the Player 1 Control Unit will be called Player 1. The person with the Player 2 Control Unit will be called Player 2.
4. Both Players should now turn their VERTICAL and HORIZONTAL controls to position themselves on the screen—with Player 1 at the left center approximately two inches from the edge; and Player 2 on the right center, also approximately two inches from the edge.
5. Both players should position their ENGLISH controls so that the raised marking on the knob is in the upright center position. (See illustration on page 7).
6. Player 2, by pressing his RESET button, will cause the Ball to appear on the screen—moving toward Player 1. Then Player 2 should turn his ENGLISH control to cause the Ball to touch Player 1.
7. Player 1 should do nothing until he is touched by the Ball. If the Ball touches Player 1, the Ball will immediately reverse and move toward Player 2. If the Ball does not touch Player 1, the Ball will move off the screen. Player 1 should then press his RESET button and the Ball will reappear on the left side and move toward Player 2.
8. Player 1 should then move his ENGLISH control to cause the Ball to touch Player 2. If the Ball misses, Player 2 should press his RESET button and steps 6, 7 and 8 should be repeated until the Ball is bouncing between Players.
9. Once the Ball is bouncing between both players, each player should take turns moving toward the bottom or the top of the screen with his VERTICAL control, and then moving in front of the Ball as it comes toward him.
10. Now each player should take turns moving the Ball with his ENGLISH control while the other player tries to move in front of the Ball by using his VERTICAL control.
11. Now you are ready to volley. Each player should use his ENGLISH control to keep the ball from striking the other player; and should use his VERTICAL control to try to hit the Ball. The player who misses the Ball must press his RESET button to bring the Ball back into play.
12. Should both players press their RESET buttons at the same time, the Ball may not appear, or may float too near the center of the screen. Simply press just one RESET button to resume normal play.
13. If an ENGLISH control has been turned to an extreme position and a RESET button pressed, the Ball may be above or below the normal viewing area. Should this happen, return the ENGLISH control to the upright center position and press the RESET buttons one at a time until the Ball appears on the screen.



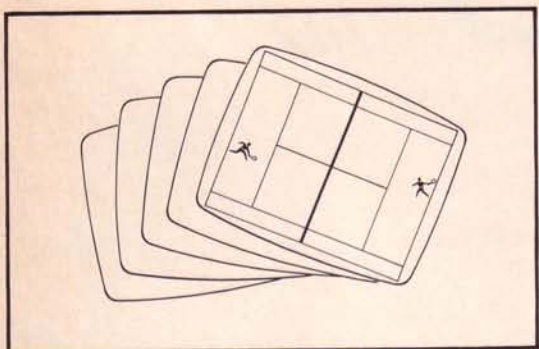

## THE OVERLAYS

Most of the games will use one of the overlays provided. Two complete sets of overlays are included. The large size should be used with a 23-inch and 25-inch (diagonal) television. The medium size is designed for 18, 19, 20 and 21-inch (diagonal) television sets. Of course, some of the games may be played without overlays—on smaller television sets.

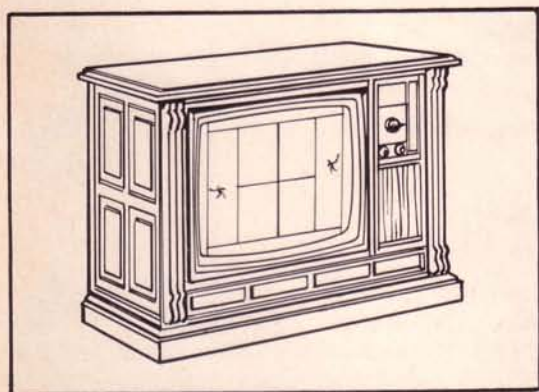

Static electricity will normally hold the overlay in place on your television screen. After positioning the overlay in place on the screen, use your hand or a soft cloth to smooth it in place. However, should the static charge not occur (and it may not, due to atmospheric conditions), two holes are provided in each overlay, which will allow you to tape the overlay to your television screen. Since the overlays are designed to fit the newer and more rectangular television screens, you may wish to trim the edges a little for a better fit.

## NOW YOU ARE READY TO PLAY

Select the Game you wish to play. Complete instructions for that game are included in the GAME RULES Section.

## CARING FOR YOUR ODYSSEY

Your game equipment has been designed to provide you with many years of enjoyment. Follow the general guidelines suggested below to help you keep your ODYSSEY System in the best working condition.

**1. The Game Box**—The two halves of the Game Box have been designed with a special place for each piece of your game equipment. Always store your game equipment in the Game Box in the same way it was originally packed.

**2. The Overlays**—You should keep the Overlays clean and free of dust (they may be wiped with a soft cloth), and *be especially careful not to crease them at any time.*

**3. The Master Control Unit**—Be careful that no foreign objects are inserted into the Game Card slot or cable sockets. Although the Master Control Unit is ruggedly built of sturdy materials, try to avoid dropping or otherwise abusing it. Clean the cabinet with a soft damp cloth.

**4. The Player Control Units**—Always unplug each Player Control cord by grasping the plug and not the cord. The controls have stops built in to prevent full rotation and to give greater ease of play; therefore, do not force the controls or turn them rapidly against the stops.

**5. The Game Cards**—The Game Cards should be kept clean and should always be handled and inserted so that no side pressure is applied. Be particularly careful that the metal foil is not damaged. Should this foil be damaged, do not use the card but obtain a new one from your dealer. *It is important to remember* that the GAME CARD is also the power switch; and therefore must be removed at the completion of play to prevent excessive battery depletion.

**6. The Game Cord**—The Game Cord may be left plugged into the Antenna-Game switch. Coil the cord up and lay it behind the television or hang it over the Antenna-Game Switch. When removing the Game Cord from the Master Control Unit, grasp it by the plug and not the cord. Never pull the Game Cord from its socket.



# GAME RULES

## TABLE TENNIS ...the basic Odyssey game that develops your electronic coordination

### GAME AID

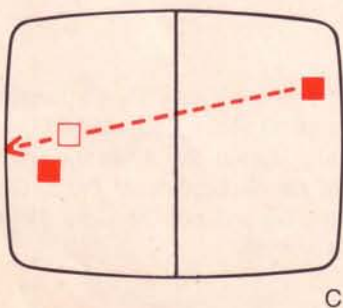
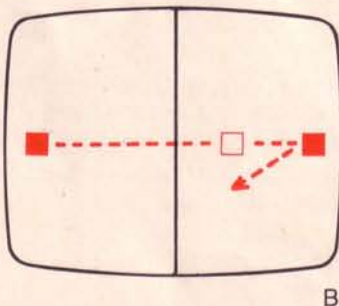
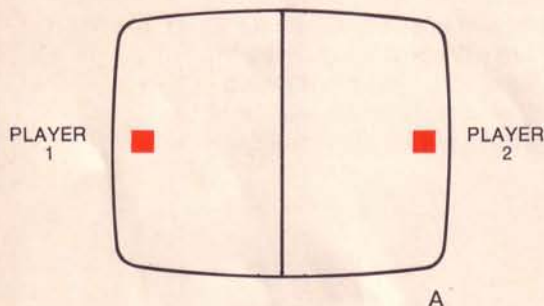

### SET UP

1. Insert GAME CARD #1 into the Master Control Unit.
2. Turn the CENTER Control on your Master Control Unit to position the vertical line in the middle of the screen.
3. Turn the SPEED Control on your Master Control Unit to the LEFT, which is the slowest setting.

### PREPARATION FOR PLAY

1. (Illus. A). Both players use their HORIZONTAL and VERTICAL controls to position themselves on the far side of the screen on each side of the white line. The player displayed on the right side of the screen *must* be controlled by the right hand Player Control Unit. Conversely, the left player is controlled by the left hand Player Control Unit. Each player must stay on his own side of the net. Your TV screen now represents a TABLE TENNIS Court as viewed from the top, with the net in the center and the players on either side.

2. Both players now set their ENGLISH Control to the upright center position.

3. (Illus. B). Press the Reset Button to set the ball in motion. When the ball bounces off your player, use your ENGLISH Control to direct the ball's flight. When the ball bounces off your opponent, he uses his ENGLISH Control to direct its flight (as described on pages 7 and 8).

**NOTE:** Initially you may find it easier to use just the VERTICAL and ENGLISH Controls to return the ball. As you become more proficient, you'll find it even more challenging to add HORIZONTAL action.

4. Players should volley the ball back and forth until they become accustomed to the play and the use of their Player Controls. The SPEED Control also should be increased gradually as you become more proficient.

### PLAY

To begin play, the players should volley the ball to determine who will serve first. For the volley to be legal, the ball must cross the net three times. The SERVER will be the last player who successfully hit the ball across the net.

The SERVER serves for five consecutive points, at which time his opponent becomes the SERVER for the next five points. Players continue to alternate serving until GAME.

### SCORING

(Illus. C). A player scores a point when his opponent misses the ball. The object is to bounce the ball off your player and maneuver it past your opponent (off the right or left side of the screen, as illustrated.)



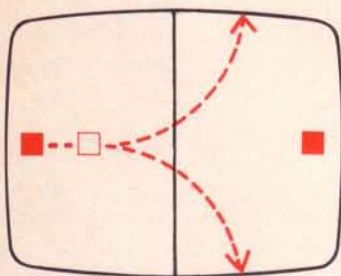

D

(Illus. D). When the ball goes off the top or the bottom of the screen, it is "off the table" and the point is lost.

"GAME" is won by the first player to accumulate 21 points. The margin of victory must be at least 2 points; such as 21 to 19, or play is continued until the 2 point margin is attained.

# TENNIS

...all the excitement of Wimbledon! You're playing regulation tennis rules as you serve, volley and score!

## GAME AIDS



GAME CARD #3

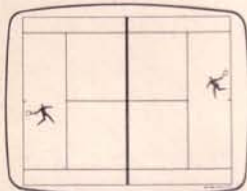

GAME OVERLAY

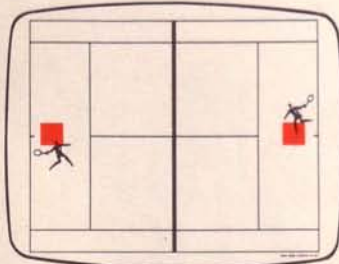

A

SERVICE BOX

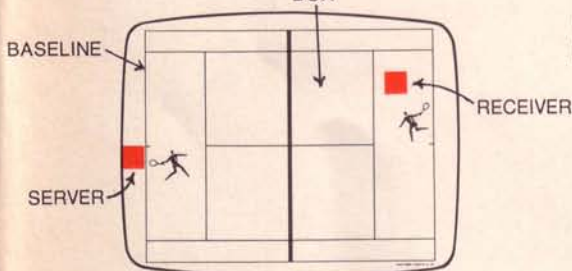

B

## SET UP

1. Insert GAME CARD #3 into the Master Control Unit.
2. Place the TENNIS Overlay on the screen.
3. The player displayed on the right side of the screen *must* be controlled by the right hand Player Control Unit. Conversely, the left player is controlled by the left hand Player Control Unit. Each player *must* stay on his side of the net.
4. Both players set their ENGLISH Control to the upright center position.
5. (Illus. A). Bring the players into position and press the Reset Button to start the volley for serve. Begin volleying at a slow speed and gradually increase the speed of the ball as you become accustomed to the play.

## PLAY

To begin play, the players should volley the ball to determine who will serve first. For the volley to be legal, the ball must cross the net three times. The SERVER will be the last player to successfully hit the ball across the net.

(Illus. B). The SERVER'S position is beyond the end line of the RIGHT side of his base line. The RECEIVER must position himself outside of his service box.



## TENNIS (Continued)

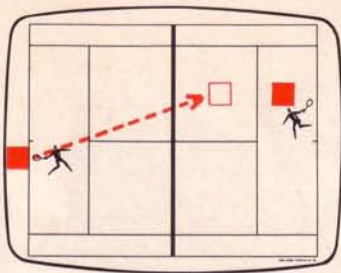

C

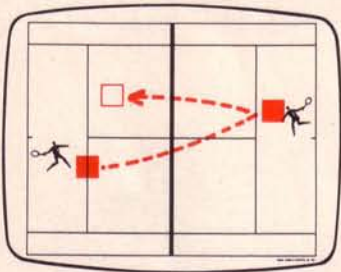

D

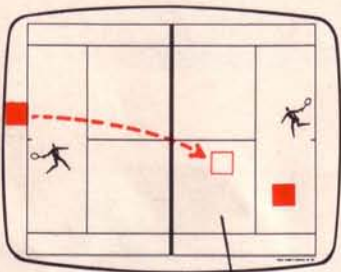

SERVICE  
BOX

E

**(Illus. C).** For a Serve to be good, the ball *must* land in the service box. The SERVER has two tries. If he fails in both, he loses the point.

**(Illus. D).** If the serve is good, the ball is in play until it is missed by one of the players. The players may move anywhere on their side of the net *after* the ball has been served.

**(Illus. E).** The next serve is from the LEFT side of the court. After a point is made, the ball must be brought to the SERVER'S side (use Reset Button). The service position always begins from the right side of the player's baseline and alternates from the right to the left side of the court after each point. At the end of the first game, the other player becomes the SERVER for the second game. The players continue to alternate serving until one player wins the "Set."

## SCORING

**GAME . . .** the SERVER is always the scorekeeper and should announce the score after each point. Scoring in tennis is as follows:

**LOVE=0 SCORE**

**15=1 POINT**

**30=2 POINTS**

**40=3 POINTS**

**GAME=4 POINTS**

**EXAMPLE:** Player 1 serves and scores a point. He announces the score "15-LOVE." He always announces his score first. On the next serve his opponent scores a point. The announcement is "15-ALL". Scoring continues until one player is awarded GAME. GAME is awarded only when a player wins by two points, such as "GAME-30." If the score is "40-All," play must continue until one player scores two straight points.

**SET . . .** The first player to win six games wins the "SET," but he must win by a margin of at least two games over his opponent.

**MATCH . . .** The first player to win 2 out of 3 SETS, wins the MATCH.



# FOOTBALL ...all the pro action! Play your strategy! Pass! Run! Kick! Touchdown!

## GAME AIDS

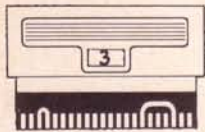

GAME CARD #3  
(For Passing and  
Kicking Plays)

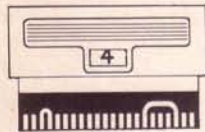

GAME CARD #4  
(For Running Plays)

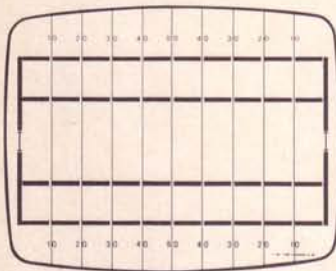

GAME OVERLAY

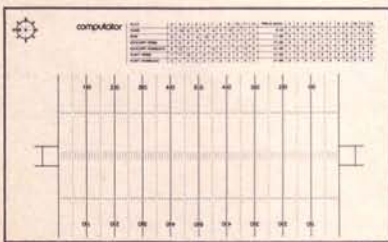

GAME  
BOARD  
FIELD



ODYSSEY STADIUM  
SCOREBOARD

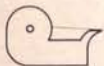

1 ROLL OF FROSTED TAPE



FOOTBALL TOKEN



YARDAGE MARKER



"PASS" DECK (20 CARDS)



"RUN" DECK (20 CARDS)



"KICK OFF" DECK  
(10 CARDS)



"PUNT" DECK (10 CARDS)

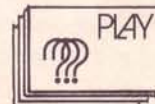

TWO "PLAY" DECKS:  
3 CARDS TO EACH DECK  
CONTAINING ...

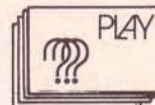

- 1 PASS CARD
- 1 RUN CARD
- 1 PUNT CARD

## A QUICK REVIEW OF FOOTBALL FUNDAMENTALS

The ball is kicked from the KICKER'S 40 yard line. When a member of the OFFENSIVE team gets possession of the ball, he runs it back. The ball is "downed" at the point where the carrier's forward motion is stopped.

The OFFENSIVE team gains yardage by passing, running, kicking and by penalties against the DEFENSE.

The OFFENSIVE team loses the ball if they fail to advance 10 yards in 4 downs, on a fumble which the DEFENSE recovers, on a pass interception and when a touchdown is scored.

## SCORING:

Touchdown:.....	6 Points
Kick after T.D.....	1 Point
Field Goal:.....	3 Points
Safety:*.....	2 Points

\*(When the ball is downed behind the OFFENSIVE team's goal on a running play, the DEFENSIVE team scores and is also the RECEIVER of the next kickoff.)



## FOOTBALL (Continued)

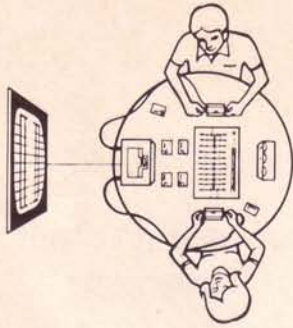

### SET UP

1. Insert GAME CARD #3 into the Master Control Unit.
2. Turn the SPEED control to slowest setting.
3. Place the FOOTBALL Overlay on the screen.
4. Set up the GAME AIDS as illustrated and shuffle each deck of cards.

### PLAY

The players flip a coin. The winner of the toss may:

- A. Elect to kick or receive. Or—
- B. Choose the goal he wishes to defend.

The opponent elects the remaining option.

### THE KICKOFF!

(**Illust. A.**) The team kicking off is positioned on its 40 yard line. The RECEIVER is positioned between the 0 and 10 yard lines.

Each player turns his ENGLISH Control to the upright center position. The ball must be on the OFFENSIVE player's side of the field (use the Reset Button).

The ball is kicked when the OFFENSIVE player presses his Reset Button. He uses his ENGLISH Control to maneuver the ball past the RECEIVER. Using his VERTICAL Control only, the RECEIVER tries to catch the ball; the ball will bounce off the RECEIVER—thus signifying a "catch". However, the RECEIVER cannot move *until* the ball passes the KICKER'S 40 yard line.

(**Illust. B.**) If the ball goes out of bounds (top or bottom of the screen), it is kicked again from five yards further back. (The ball is then kicked on the KICKER'S 35 yard line.)

(**Illust. C.**) If the RECEIVER misses the ball and the kick goes into the end zone, it is an AUTOMATIC TOUCHBACK. The ball is then placed on the RECEIVER'S 20 yd. line and it's "FIRST AND TEN."

(**Illust. D.**) If the RECEIVER catches the ball (the light bounces off of the player), the action on the overlay stops and play is continued on the Game Board. The RECEIVER is entitled to a "runback," but first, the KICKER picks a card from the top of the Kickoff Deck to determine the kick yardage.

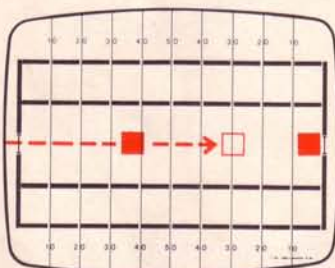

A

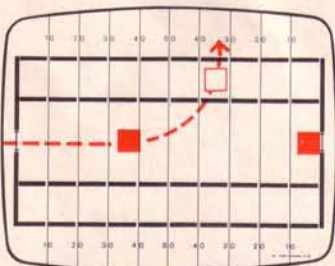

OUT OF BOUNDS

B

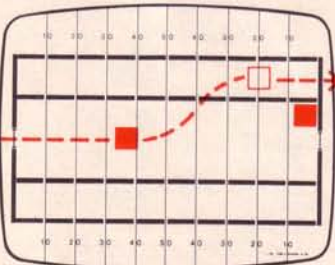

AUTOMATIC TOUCHBACK

C

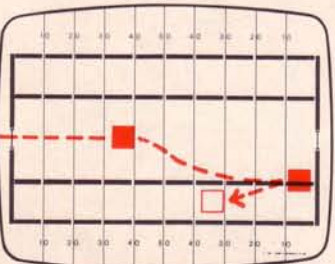

RECEIVER IS ENTITLED  
TO RUNBACK

D



## WIND FACTOR:

The KICKER rolls the dice and determines the wind effect from the "computator" on the Game Board playing field (kickoff/wind). Find the dice total by reading the white numbers across (dice total), then reading down the Play Column, to find the "kickoff/wind" yardage—penalty or bonus. If the wind is *behind* the KICKER, the yardage is *added*—if kicking *into* the wind, it's *subtracted*. (The wind is always in a constant westerly direction, as indicated on the Game Board compass.)

(**Illust. E**). The location of the ball is marked with the Football Token on the Game Board. *The Score Board is maintained throughout the game (touchdowns, downs, quarter, etc.).*

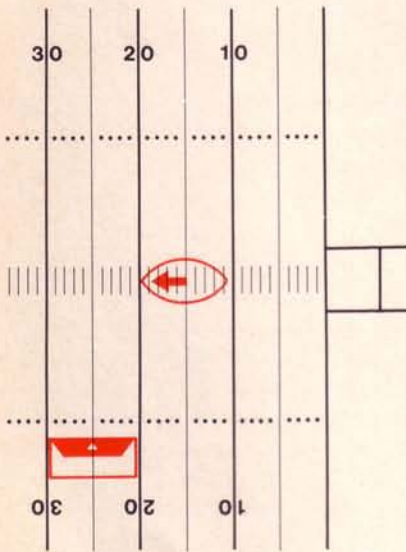

E

FOOTBALL TOKEN IS ON 20 YD. LINE. YARDAGE MARKER SHOWS YDS. NEEDED IN ORDER TO GAIN A "1ST DOWN."

## THE RUNBACK!

When the RECEIVER catches the ball, he rolls the dice and reads his yardage from the "kickoff runback" column of the computator. An "X" indicates a break-away run. (The runner rolls the dice again and multiplies the total by 5 to determine the yardage he gained.) The Football Token is then moved on the Game Board Field to indicate its new position.

## PLAY SELECTION!

After the token is moved to mark the ball's position, OFFENSIVE player decides on his next play. He places one of his three "play" cards face down on the table. The DEFENSE tries to outguess him and places one of his "play" cards face down. The players turn up their play cards simultaneously. If the DEFENSE has correctly guessed the OFFENSIVE strategy, it will have a profound effect on the outcome of the play! (This is explained on page 16)

## ACTIVATING THE PLAY!

The OFFENSE puts the appropriate Game Card into the Master Control Unit. (Game Card #3 for passing, kicking or punting; Game Card #4 for running.) After each play has been noted on the Game Board, the OFFENSE positions his light on the overlay in the same place as the Football Token. The DEFENSE takes his position one light square away.



FOOTBALL (Continued)

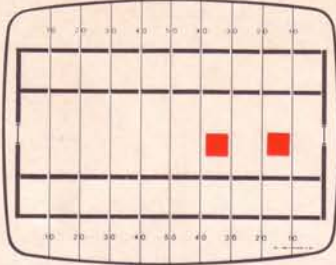

**F**  
PLAYERS ARE IN FORMATION.  
OFFENSE IS ON 20 YD. LINE  
READY TO ACTIVATE "RUN"  
PLAY.

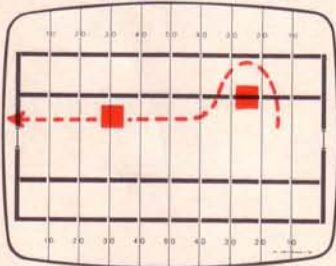

**G**  
A SUCCESSFUL RUNNING PLAY

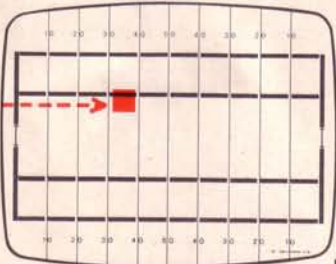

**H**  
PLAYER HAS GAINED 15 YARDS  
BASED ON CARD SHOWN BELOW.

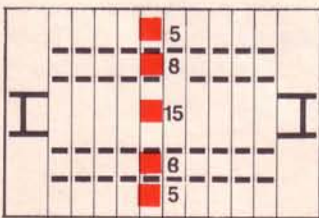

**I**  
RUN CARD SHOWS YARDS  
GAINED ON SUCCESSFUL  
RUN PLAY.

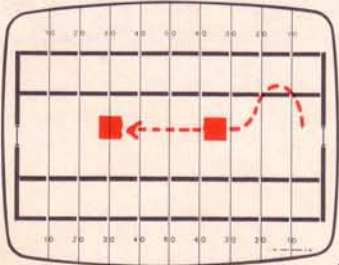

**J**  
OFFENSE IS CAUGHT IN  
UNSUCCESSFUL RUN PLAY.

## THE RUNNING PLAY! (Game Card #4)

**(Illust. F.)** The OFFENSE positions his player on the line of scrimmage. The DEFENSE positions himself one light square away, as illustrated.

Each player takes his hand off his HORIZONTAL Control and keeps it on the table, but may maneuver his VERTICAL Control as the signals are called.

The OFFENSE calls the signals—three to five 1 or 2 digit numbers (32! 64! 76! Hike!) on "hike," each player races his hand to his HORIZONTAL Control.

**(Illust. G.)** The OFFENSIVE player tries to maneuver the ball past his opponent. The OFFENSIVE player may not go off the top or the bottom of the screen, or he is out-of-bounds and suffers a five yard penalty.

**If the OFFENSIVE player outmaneuvers his opponent** and passes through the goal side of the screen, the play is *successful*. The OFFENSIVE player brings his player back "on" screen by using only his HORIZONTAL Control. **(H)**. Play is stopped on the game overlay and resumes on the Game Board. The OFFENSIVE player then takes a card from the Run Deck to determine the yardage gained. **(I)**. If his player is touching a HORIZONTAL line, he gets the greater yardage indicated on the Run Card. The football token is moved to indicate the gain.

If a "breakaway" run card is picked, the OFFENSE rolls the dice and multiplies the number by 5 to determine the yardage gained.

**If the OFFENSIVE player is unsuccessful in trying to outmaneuver his opponent**, one of the players will vanish from the screen, thus signaling that body contact has been made. **(Illust. J)**. Play is stopped on the game overlay. There is no yardage gained and **if the DEFENSE did not guess the OFFENSE'S play**, there is no penalty.

Important—however, **IF the DEFENSE guessed the OFFENSE'S strategy**, he rolls the dice to determine the penalty against the OFFENSE team. The results are read from the "run row" of the computerator. The football token is moved to indicate the penalty. An "X" in the computerator Run Row indicates a fumble with the DEFENSE recovering.



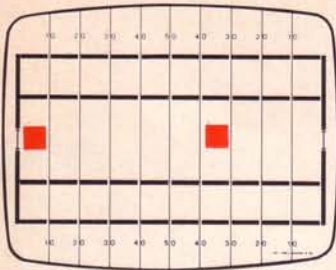

PLAYERS ARE IN FORMATION. OFFENSE IS ON 35 YD. LINE READY TO ACTIVATE "PASS" PLAY IN THIS EXAMPLE.

K

## THE PASSING PLAY! (Game Card #3)

(**Illust. K**). The OFFENSE positions his team on the line of scrimmage. The DEFENSE drops back to the segment between 0 and 10 yards. The OFFENSE calls signals and, at "hike!" presses his RESET Button to throw the pass.

The OFFENSIVE player uses his ENGLISH Control to maneuver the ball past the DEFENSE. If the ball goes off the top or the bottom of the screen, the pass is incomplete. The OFFENSE begins the next down. The ball **MUST** go off the goal side of the screen to be a completed pass! (**Illust. L**).

**If the pass is completed**, the OFFENSIVE player picks from the Pass Deck to determine the yardage gained. If a "bomb" card is picked, the OFFENSE rolls the dice and multiplies by five to find the yardage gained. The football token is moved to indicate the gain.

**If the ball bounces off** the DEFENSIVE player, the pass is incomplete; (**Illust. M**) and if the DEFENSE *did not* guess the play, the pass is simply incomplete. *There is no penalty.*

**However, IF the DEFENSE did guess the play**, the DEFENSIVE player rolls the dice to determine the penalty against the OFFENSIVE team. He reads the result in the "pass row" of the computer. An "X" in the "pass row" indicates an interception. The Football Token is moved to indicate the penalty.

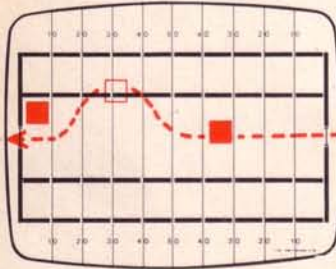

A SUCCESSFUL PASS PLAY.

L

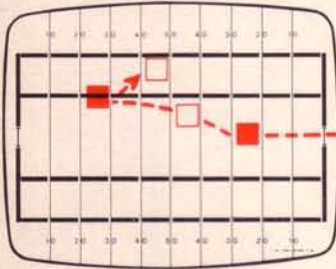

AN UNSUCCESSFUL PASS PLAY.

M

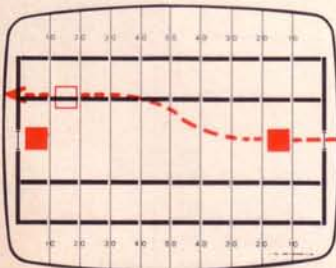

A SUCCESSFUL PUNT.

N

## THE PUNT! (Game Card #3)

The OFFENSE is on the line of scrimmage. The DEFENSE is between the 0 and 10 yard lines.

The OFFENSE calls signals. At "hike!" he presses his RESET Button to make the punt. Using his ENGLISH Control, he tries to maneuver the ball past the RECEIVER. (**Illust. N**).

**If the punt goes past the RECEIVER** and off the screen, there is no runback. The KICKER then picks from the Punt Deck to determine the yardage. Then the dice are rolled and the wind effect is read from the computer (punt/wind)

**If the punt is caught by the RECEIVER**, he runs it back. (The ball will bounce off the RECEIVER, thus signifying a "catch.") (**Illust. O**). Play is stopped on the overlay and resumes on the Game Board.

The RECEIVER rolls the dice and reads the result in the "punt runback" row of the computer. An "X" in the "punt runback" row indicates a "breakaway." The RECEIVER again rolls the dice and multiplies the dice total by 5 to determine his total yardage gained. The Football Token is moved on the Game Board to indicate the new position.

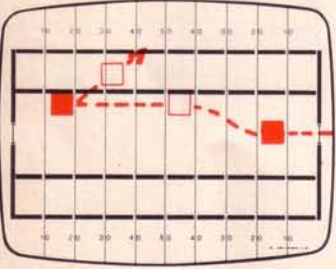

UNSUCCESSFUL PUNT. RECEIVER IS ENTITLED TO RUNBACK.

O



### **THE FIELD GOAL:**

A player can declare and try for a field goal if he is within the yardage range indicated on the computer chart (the DEFENSE'S 0 to 50 yd. line). He merely rolls the dice and reads from the correct yardage row to determine the results:

**"+" is a successful field goal.** The team gets 3 points and there is a new kickoff.

**"0" is an unsuccessful field goal.** The opposition takes over on their own 20 yard line.

### **PENALTIES:**

**Offsides:** If a player crosses the line of scrimmage before the ball is ("hiked").  
5 yards.

**Illegal Procedure:** If a player activates a play without using the correct game card. 5 yards.

### **GAME:**

The game is divided into four quarters; each quarter has 20 plays. Players switch ball and field positions after each quarter. Reshuffle Pass, Run, Punt and Kick Decks at the start of each quarter.

### **THE CLOSING MINUTES!**

During the last four plays of each half, if the OFFENSE is inside the DEFENSE'S 40 yard line, he can declare and throw a "bomb." He inserts Game Card #3 and follows the instructions outlined for the PASSING PLAY. If he is successful, he rolls the dice and multiplies by 5 to determine the yardage gained. If his attempt is unsuccessful, the ball is automatically intercepted and his opponent gets a breakaway runback and merely rolls the dice and multiplies by 5 to determine his yardage. In either case, the change in position is noted on the Game Board and play is resumed.



# HOCKEY ... go for the cup in Odyssey Stadium as you face-off, maneuver the puck and dig for the net!

## GAME AIDS:

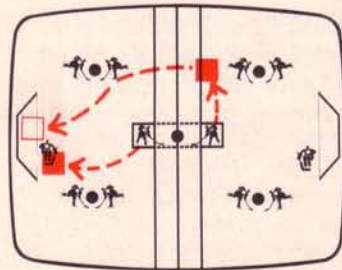
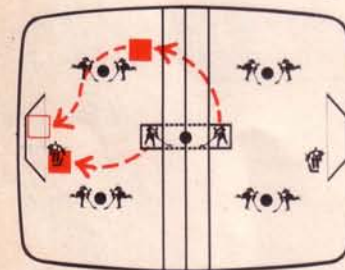
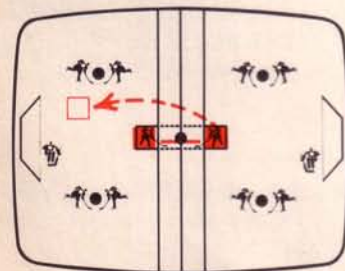
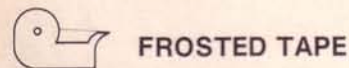
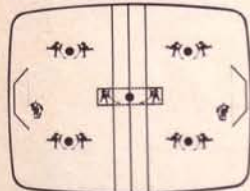

## SET UP

1. Insert GAME CARD #3 into the Master Control Unit.
2. Turn the SPEED control to the slowest setting.
3. Place the HOCKEY Overlay on the screen.
4. Each player sets his ENGLISH control to the upright center position.
5. (Illustr. A). Players move their lights into the center positions for the Face-Off.
6. Press the Reset Button to activate the "PUCK." It should move back and forth between the centers. Some slight ENGLISH adjustment may be necessary to accomplish this. Gradually increase the speed of the puck as you become more proficient in playing HOCKEY.

## PLAY

Play begins with a Face-Off at center ice.

**FACE-OFF:** Both players start with their hands off the controls and placed on the table, floor or lap.

On the count of three, race your hands to your Player Control Unit and use your ENGLISH control to try to drive the "PUCK" past your opponent. (Illustr. B). (Players alternate counting for each FACE-OFF.)

**SHOT ON GOAL: (Illustr. C and D).** The offense must cross the red line, into his opponent's territory, *before* making a SHOT ON GOAL that will count, otherwise, the goal does not count. A new Face-Off is made from center ice. Also, after each GOAL is made, there is a new center Face-Off.



HOCKEY (Continued)

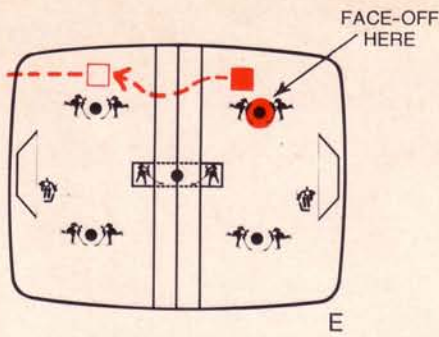

**ICING: (Illust. E).** If the PUCK crosses the red line and goes off the goal edge of the screen without entering the net, the PUCK is ICED and a Face-Off is held on the wing of the offensive player's ice.

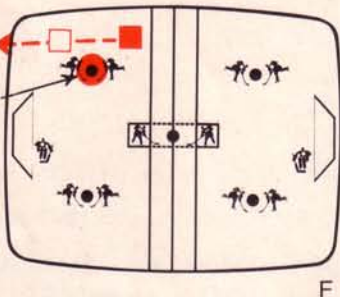

**(Illust. F).** If the PUCK goes past the net, and if the Offensive player made the shot while on the Defender's ice, the Face-Off is held on the Face-Off Circle closest to the side where PUCK went off.

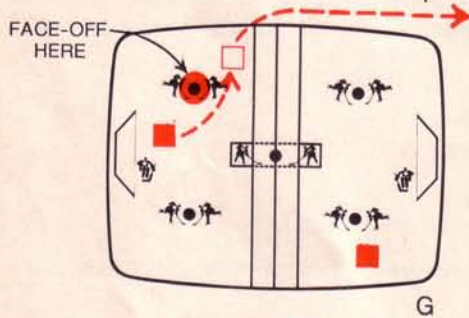

**OFFSIDE: (Illust. G).** If the "PUCK" goes off the top or the bottom of the playing surface and does *not* return to the rink before reaching the goal edge of the screen, it is considered OFFSIDE. The Face-Off is held in the Face-Off circle nearest the point where the Puck went out of play.

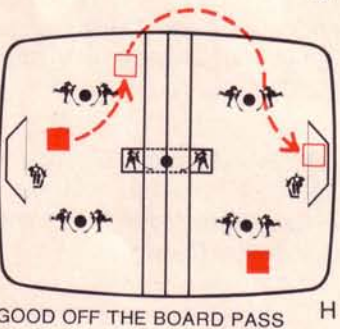

**OFF THE BOARD PASS: (Illust. H).** If the "PUCK" goes off the top or the bottom of the playing surface and *does* return to the rink before reaching the goal edge of the screen, it is considered a good Off The Board's Pass.

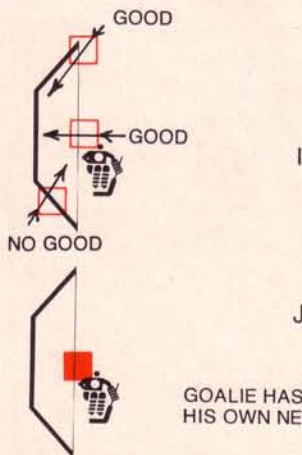

**GOALS: (Illust. I).** The colored nets of the goal must be lighted to score a goal. The puck may not enter the goal through the black line. The score is 1 point for each goal. In order for a goal to be considered legal, the PUCK must enter the net in one of the ways illustrated.

**PENALTY: (Illust. J).** If the Goalie enters his own colored net area while defending his Goal, it is a FOUL. The offending Goalie must then use only one hand on his Player Control for the next two plays.

**THE GAME:** The GAME consists of three PERIODS. Each PERIOD is limited to 20 plays. A new play is considered to be started each time the RESET button is pressed. Use the Scoreboard to keep track of the plays.

(Place frosted tape over the Scoreboard. Pencil scores may be erased.)



# SKI

...your private plane has just landed on a small airstrip deep in the heart of the Vazhdok Mountains. Lace up your boots, put on your skis and see how you do on these hazardous slopes! (For 1 or more players.)

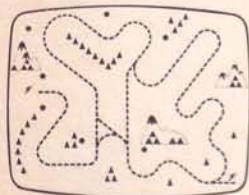

## GAME AIDS

GAME CARD #2

GAME OVERLAY

STICK-ON SKI MARKERS (for Game Version "C") from Odyssey Game Accessory Sheet.

## SET UP

1. Insert GAME CARD #2 into the Master Control Unit.
2. (Illustr. A). Use your controls to take one of the players off the screen.
3. Place the SKI Overlay on the screen.
4. (Illustr. B). Position the remaining light behind the ski figure at the start of the course.
5. Decide which of the 3 trails you are going to ski:

... **The St. Moritz Trail (Illustr. C)**—The beginner trail designed to acquaint the new "skier" with all the fundamentals required to build his confidence and skill to advance to the longer trails.

... **The Aspen Trail (Illustr. D)**—The intermediate trail, which is longer than the St. Moritz Trail, and features more jolts and hazards—a real challenge to the "weekend skier!"

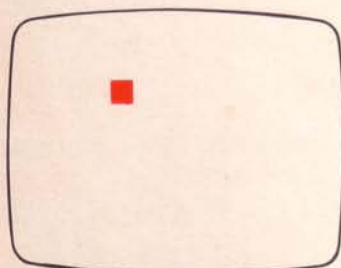

A



B



C

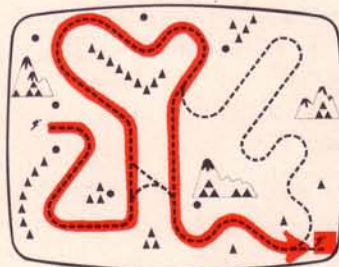

D



SKI (Continued)



THE TRAIL WINDS AROUND E 1



AND CONTINUES AS ILLUSTR'D. E 2

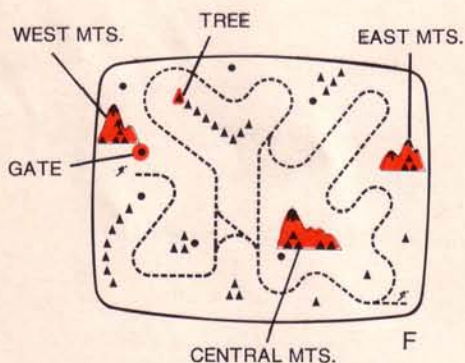

... The Olympic Trail (Illustr. E)—The advanced trail, which is the longest and most difficult trail, demanding the utmost in speed, skill and accuracy.

## PLAY

There are three game variations which you can play. To begin competition in any of the three versions, one player should signal when the "skier" is to start his run (1, 2, 3, go!). The "skier" then begins his descent down the trail. When the "skier" completes his run, the other player(s) follow down the trail. The HORIZONTAL and VERTICAL Controls are used to guide the "skier." After each "skier" has made three runs, the score is tabulated.

## I. POINT METHOD

(Illustr. F). Each time you go off the trail, (light not visible) you receive a *penalty* of 5 points plus the following penalties:

If you light a gate .....	10 Points
If you light a tree .....	15 Points
If you light	
East Mountain .....	25 Points
Central Mountain .....	30 Points
West Mountain .....	25 Points

The Player with the *fewest* points wins.

## II. TIME METHOD

Race against the second hand of a clock. Each time your light goes off the trail, add 1 second to your time, PLUS the following time penalties:

If you light a gate .....	Add 2 Seconds
If you light a tree .....	Add 3 Seconds

If you light the East Mountain, the Central Mountain or the West Mountain, you are *disqualified* for that run. The Player with the *best* time wins.

## III. DISTANCE AND TIME METHOD

- Race against the second hand of a clock. The player skis until he goes off the trail.
- A ski marker (from the game accessory sheet) is placed at the location the player's light went off the trail. The time is noted.
- The second player tries to beat the first player's time to the marker... and continues skiing down the trail until he goes off, thus setting a new record. A marker is then placed at the position he went off the trail and his time is also noted.
- The next player tries to beat the first and second player's time and distance records.
- Each skier gets three attempts to better the time and distance record.
- The winner is the player who skis the *longest distance in the shortest time*.



# SUBMARINE

... navigate your convoy into safe harbor as you pass through dangerous, submarine infested waters!

## GAME AIDS



GAME CARD #5

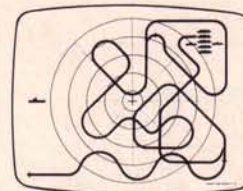

GAME OVERLAY

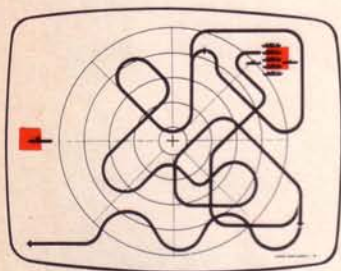

A

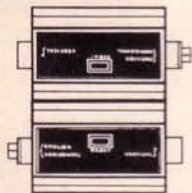

B

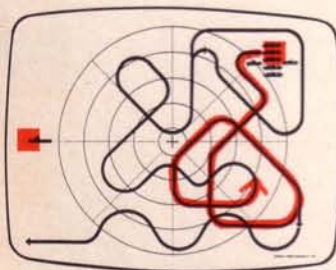

C

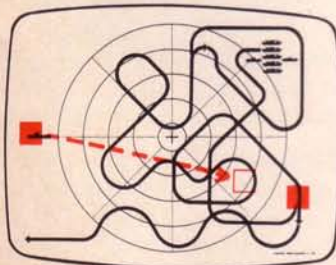

D

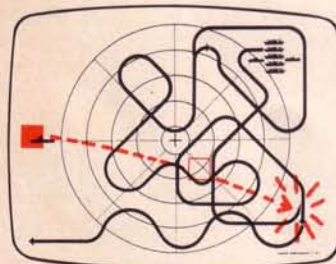

E

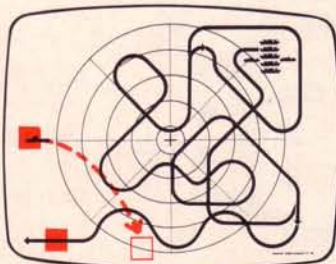

F

## SET UP

1. Insert GAME CARD #5 into the Master Control Unit.
2. Place the SUBMARINE Overlay on the screen.
3. Both players set their ENGLISH Controls to the upright center position.
4. (Illust. A). The left player, Player 1, is the SUBMARINE CAPTAIN and takes his position on his submarine. The right player, Player 2, is the CONVOY COMMANDER and takes his position on his fleet.
5. (Illust. B). Both control units are placed together, as shown.

## PLAY

(Illust. C). Using his HORIZONTAL and VERTICAL Controls, the CONVOY COMMANDER navigates his ships (an unlimited number is represented by the ships on the game overlay) along the blue sea lanes.

(Illust. D). The SUBMARINE CAPTAIN launches his torpedoes by pressing his RESET Button. He directs the torpedo's path toward the convoy with his ENGLISH control.

(Illust. E). When a hit is made, both the torpedo and the ship disappear from the screen. The SUBMARINE CAPTAIN reloads his torpedo tube by pressing the CONVOY COMMANDER'S RESET Button. The SUBMARINE CAPTAIN keeps count, out loud, of each ship lost to torpedoes or mines. If the convoy leaves the sea lane, it signifies that it has run into mines and one of the ships is lost.

(Illust. F). When the convoy reaches the end of the Sea Lane Path, and is off the screen, it signifies that it has made it into a safe harbor. The CONVOY COMMANDER undertakes 2 more missions and the players then trade controls. The WINNER is the SUBMARINE CAPTAIN who *sinks the most ships* in the 3 missions—from torpedoes or mines.



# CAT and MOUSE ...can the clever mouse elude the cantankerous cat? A hilarious electronic addition game of hide and seek.

## GAME AIDS

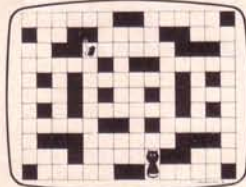

STICK-ON NUMBERS  
(from Odyssey Game Accessory Sheet)

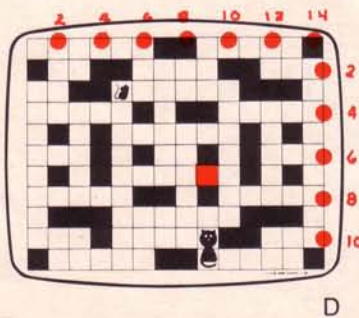
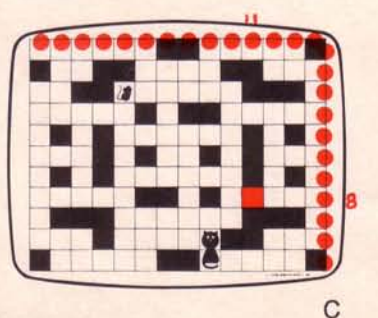
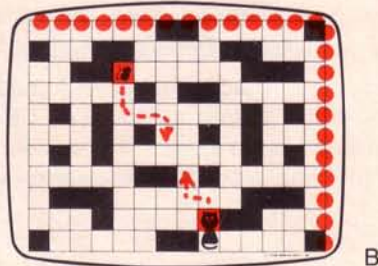
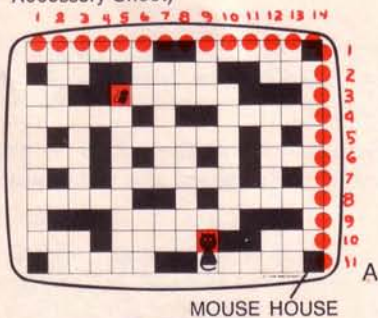

## SET UP

1. Insert GAME CARD #4 into the Master Control Unit.
2. Place the CAT and MOUSE Overlay on the screen.
3. (Illustr. A). Place the numbers (from Accessory Sheet) on the Overlay.
4. Player Number 1, the left player, is the CAT. Player Number 2, the right player, is the MOUSE.
5. Using the HORIZONTAL and VERTICAL Controls, position the MOUSE's light on the MOUSE figure and the CAT's light on the CAT figure. (Illustr. A). The blue square in the lower right hand corner is the "Mouse House." The other blue squares represent walls and furniture.

## PLAY

Play begins when one player counts aloud to three.

(Illustr. B). The MOUSE must get to his house without being caught by the CAT. The CAT, on the other hand, tries to catch the MOUSE as quickly as he can. Neither the CAT nor the MOUSE may enter the blue squares. If either player crosses a blue square, he must return immediately to his starting position (CAT or MOUSE figure) before continuing the chase.

The MOUSE light will be extinguished if caught by the CAT. Play is then stopped.

## SCORING

(Illustr. C). At the point of interception where the CAT extinguishes the MOUSE, the points accumulated by the MOUSE for the run are marked down on a sheet of paper. Every square has a point value, which is arrived at by adding the numbers in the vertical and horizontal columns as shown: The CAT player in the illustration has extinguished the MOUSE in a square with a point value of 19. (Top row 11, Side column 8). The MOUSE then receives 19 points for that run.

The MOUSE gets 3 runs to a "Set." Then the players exchange controls, and the opponent becomes the MOUSE. The player with the *most total points* in his 3 runs as the MOUSE is the winner.

## GAME VARIATION

(Illustr. D). Remove all the odd numbers from the Game Overlay. Play is as before, except if the MOUSE is caught in an unnumbered square, his score is zero for that run.



# HAUNTED HOUSE ...you are the detective groping in the dark as cats, bats, skeletons and a disappearing ghost guide you to a secret treasure! Fun for all ages. (For 2 or more players.)

## GAME AIDS

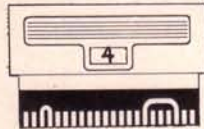

GAME CARD #4



GAME OVERLAY



30 CLUE CARDS



13 SECRET MESSAGE CARDS



## SET UP

1. Insert GAME CARD #4 into the Master Control Unit.
2. The left player, Player 1, is the DETECTIVE. The right player, Player 2, is the GHOST. Position the DETECTIVE and GHOST lights, as shown at left.
3. Place the HAUNTED HOUSE Overlay on the screen.
4. Shuffle the SECRET MESSAGE Cards and place them face down in front of the DETECTIVE. Arrange the CLUE CARDS in numerical order and place them in front of the GHOST.

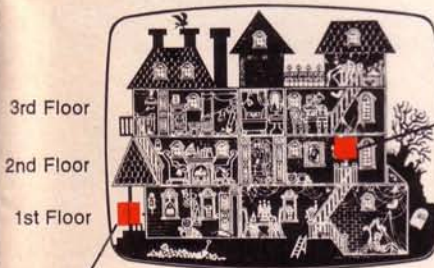

## PLAY

(**Illust. A.**) While the DETECTIVE turns his head, the GHOST positions his light behind any of the clues, *except* the bat on the 3rd floor. (The clues are the translucent objects in the house, other than windows.) The GHOST makes himself disappear by maneuvering the DETECTIVE's light toward the GHOST until it touches and extinguishes the GHOST's light. (Use the HORIZONTAL and VERTICAL Controls.) The GHOST player then returns the DETECTIVE's light to the position shown in the illustration. The GHOST now tells the DETECTIVE to turn around.



(**Illust. B.**) The DETECTIVE enters the house through the door at left. The other player gives the DETECTIVE a Clue Card for each clue the DETECTIVE lights on his search for the secret treasure.



## HAUNTED HOUSE (Continued)

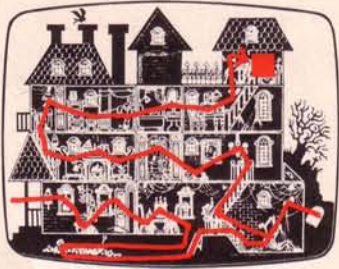

C

**(Illust. C).** BUT . . . the DETECTIVE must gather his clues in their proper order. (See illustration). If the DETECTIVE lights a clue out of sequence, it is considered to be sloppy police work and he does not collect any of the clues he passed by. He continues his search for the Secret Treasure.



D

**(Illust. D).** FURTHERMORE . . . If the DETECTIVE reveals his whereabouts at a window by lighting it, he must return to his last clue position and give back that Clue Card to the GHOST.

When the DETECTIVE approaches the clue just before the GHOST's hiding place, the GHOST reveals himself by pressing his RESET Button, and says "Boo!" (The GHOST must remain in his hiding place until the Secret Treasure is discovered by the DETECTIVE).

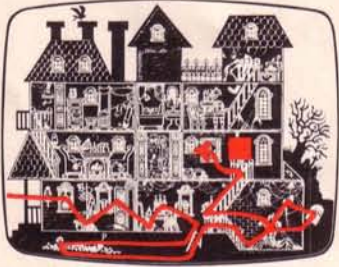

E

DETECTIVE MUST GO AROUND  
GHOST WHO REVEALS HIMSELF  
IN THIS EXAMPLE  
(IN CHANDELIER.)

**(Illust. E).** The DETECTIVE must be very careful not to get too close to the GHOST . . . or the GHOST will disappear and, as a penalty, the GHOST takes half of the Clue Cards the DETECTIVE has won. The DETECTIVE may elude the GHOST by going around him (finding his way through secret passages and hidden staircases, which may even take him to another floor). He may use clues he has already encountered as guides to his next clue, but he does not collect additional Clue Cards for relighting them.

## SECRET MESSAGES

The DETECTIVE takes a *secret message card* when he reaches the mysterious letter on the desk on the 3rd floor. He must follow the instructions written on the card. If he is instructed to a previous clue position, he returns to that position, and play continues, with the DETECTIVE relighting the clues in the same sequence as before. (He now has the opportunity to win previously missed clues.) If the clue position is one in which the GHOST is hiding, the DETECTIVE *still* forfeits half of his Clue Cards. (Always counting from the haunted house entrance).

When the DETECTIVE reaches the Secret Treasure, he counts his Clue Cards. It is now the other player's turn to be the DETECTIVE. Play begins as before. Write down your score so you do not forget it.

The DETECTIVE who gathers the most Clue Cards wins.



# ANALOGIC

...a space race through the numeric maze of a computer charted galaxy! A fascinating electronic addition game for all ages!

## GAME AIDS

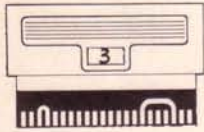

GAME CARD #3

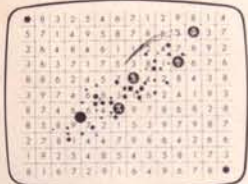

GAME OVERLAY



GAME CHIPS (use 16 red chips)

ODD

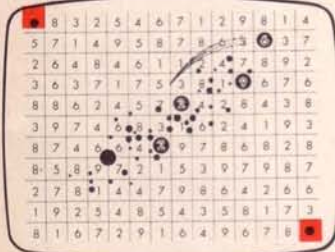

EVEN A

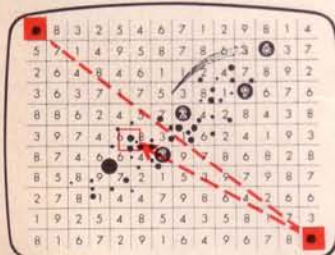

B

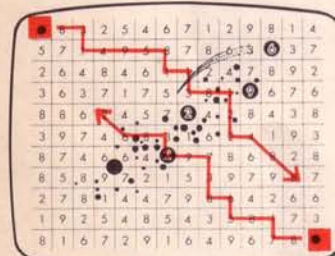

C

## SET-UP

1. Insert GAME CARD #3 into the Master Control Unit.
2. Place the ANALOGIC Overlay on the screen.
3. Set the SPEED control to the slowest setting.
4. (Illust. A). Using HORIZONTAL and VERTICAL Controls, the left player, Player 1, goes to the planet EVEN. The right player, Player 2, goes to the planet ODD.
5. Both Players set their ENGLISH controls to the upright center position.

## PLAY

(Illust. B). The players establish interstellar contact by activating their light beam transceivers. (The RESET button is pushed and the light bounces diagonally between both players. Use the ENGLISH control to determine the correct path of the light).

The players flip a coin to see who moves first. The player from the planet ODD tries to reach the planet EVEN before the player from the planet EVEN reaches the planet ODD.

If the player from the planet ODD starts the game, he may *move only to an odd numbered square*. If a player from the planet EVEN starts the play, he may *move only to an even numbered square*.

(Illust. C). The players may *move one square in any horizontal or vertical direction*. They may, under special circumstances, move in a diagonal direction. This will be explained later (on page 28).



**ANALOGIC** (Continued)

The principle for the succeeding moves of the game: The EVEN player may move only to a square whose number combines with ODD'S last move to *total to an even number*. ODD may move to a square whose number *totals* to an ODD figure when combined with EVEN'S last move.

EXAMPLE: ODD Plays First.

ODD: Moves to three

EVEN: Moves to five (3 + 5 = 8)

ODD: Moves to six (5 + 6 = 11)

EVEN: Moves to two (6 + 2 = 8)

And so on . . .

**NOTE:** Each player must total figures aloud before they move.

Each player uses his ENGLISH control to maintain interstellar contact. If the player who has control of the interstellar beam misses contact, he must go back 1 space and his opponent receives a Diagonal Chip good for one diagonal move at any time during the game. (Use RESET Button to reactivate beam.)

**(Illust. D).** Once the players are within any 3 vertical columns of each other, interstellar contact is no longer necessary and the beam is allowed to disappear off the screen.

**(Illust. E).** When a player passes through the Planetary Belt, he receives a Diagonal Chip for each time he touches one of the five planets. Players may not occupy the same square at the same time.

The first player to reach his opponent's planet wins the game.

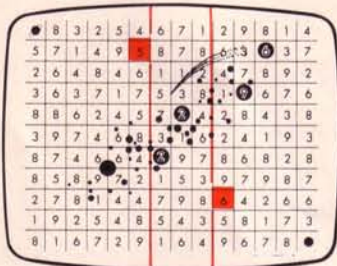

D

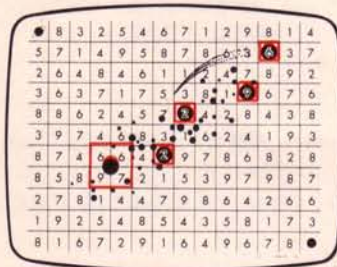

E

**GAME VARIATION:**

Use the interstellar light as a timer for the game of play. Each player must announce his move within four traverses of the beam or he forfeits his turn. All other playing procedures remain as outlined.



# ROULETTE

...all the casino action of Monte Carlo! Place your bets and try to break the bank! (For 2 or more players.)

## GAME AIDS

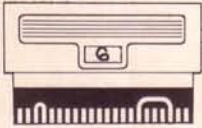

GAME CARD #6

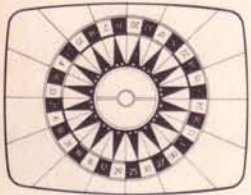

GAME OVERLAY



ROULETTE LAYOUT BOARD



WHITE RED BLUE

CHIPS

## SET UP

1. Insert GAME CARD #6 into the Master Control Unit.
2. Place the ROULETTE Overlay on the screen.
3. The players divide the chips and each receives \$1,000.00 of paper money.

White Chips = \$ 5.00

Red Chips = 10.00

Blue Chips = 50.00

One player is the BANKER and retains custody of the balance of the cash.

## HOW TO PLACE BETS

The players make their bets by placing their chips on the Roulette Layout Board. Several kinds of bets are possible and the odds are indicated on the Roulette Layout Board. (See page 30 for illustration.)

- To make a one-number bet, cover the entire number with a chip.
- To make a two-number bet, position a chip so that it falls between two numbers.

PLAY MONEY





## ROULETTE (Continued)

- To make a four number bet, position a chip so that it covers the corners of the four numbers.
- To make a six number bet, put a chip at the end of the row of numbers, as shown.

You may bet on red or black  
and  
odd or even  
and  
0 and 00

**THE ILLUSTRATION BELOW SHOWS THE PROPER  
CHIP PLACEMENT FOR THE VARIOUS BETS**

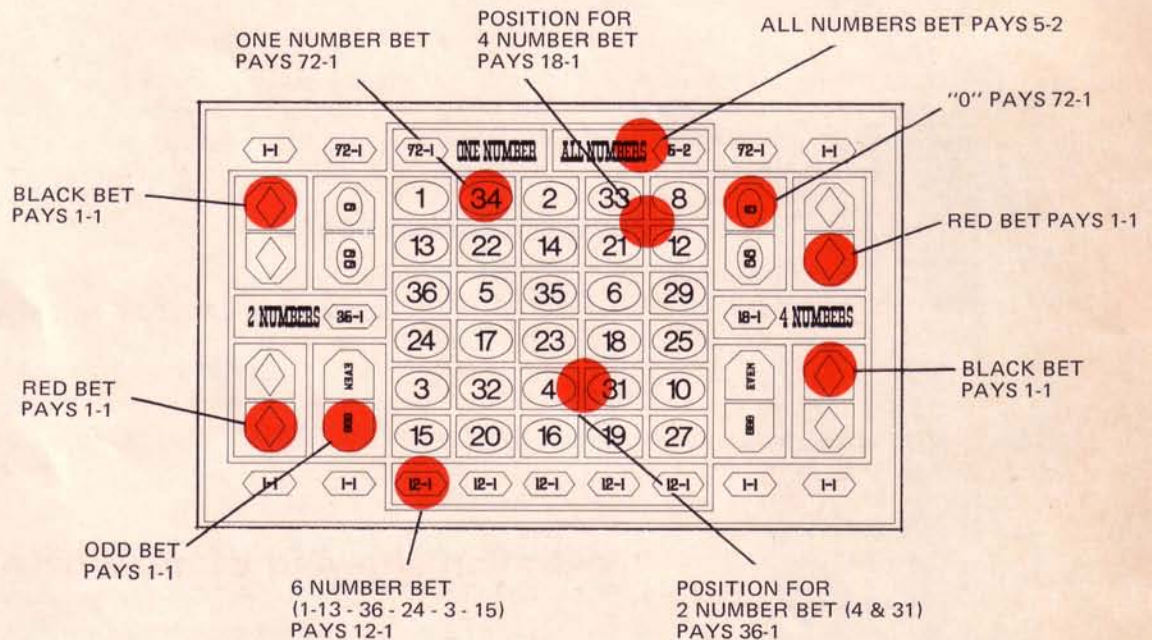

## PLAY

Only the Player Control #2 is used to play Roulette. First, its electronics are "shuffled": the BANKER depresses the RESET Button and offers the VERTICAL or HORIZONTAL control to any one of the players, who then randomly turns that particular control with his eyes closed. The same procedure is followed for the remaining control (vertical or horizontal).

The BANKER may present the control in *any* position. (Right-side-up, on its side or up-side-down.) It is important that the dial settings be random.

The BANKER then releases the RESET Button and lets the ball fall into place on the wheel. If the ball does not appear on the Roulette Game Overlay, the BANKER has the electronics "reshuffled." If the ball falls on "0" or "00," the house wins *all one-to-one bets*.

Good Luck!



**THE FOLLOWING ILLUSTRATIONS SHOW SOME OF THE COMBINATIONS WHICH WOULD WIN THE BETS MADE ON THE ROULETTE LAYOUT.**

SPIN AGAIN

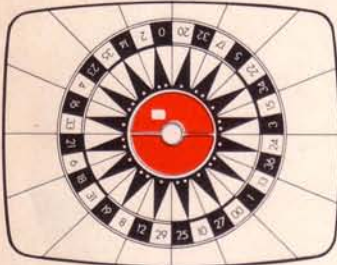

If ball falls in center red circle it is out of play and electronics in the control unit are "reshuffled."

ODD  
EVEN

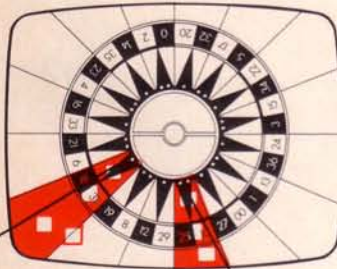

**Odd—Even Bet.** Alternating single and double dots appear on the yellow points of the roulette wheel. These indicate *odd* and *even* areas. A ball landing in any of the locations indicated in illustration would win.

ODD

EVEN

BLACK  
RED

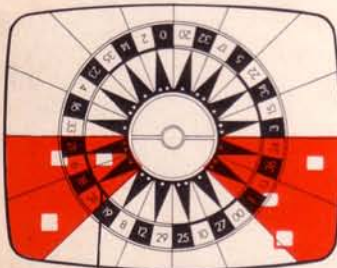

The outcome of a Black/Red bet is determined by the color of the segment in which the ball falls.

BLACK BAND INDICATES GOOD BLACK SEGMENT

**Illustration showing winning bets for...**

**Even and Red bets**

- Any one number, two number, four number, six number, or all number bets which included number four is a winner.
- The even bet wins.
- The red bet wins.

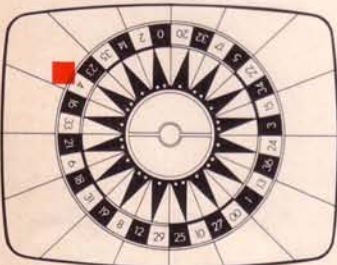

**Two-number bets**

If a ball falls between two numbers, both numbers' win. In this illustration, numbers 12 and 29 win.

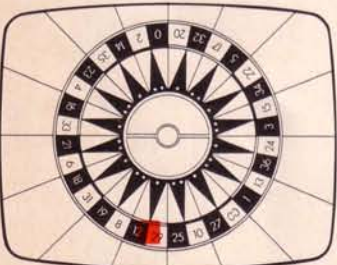

NUMBER BETS ARE 12 & 29



# STATES

A fun maze of riddles and rhymes that helps you learn the states and their capitals!

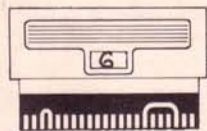

## GAME AIDS

GAME CARD #6



GAME OVERLAY



ACCESSORIES: STICK ON "GREAT LAKES BONUS"  
(from Odyssey Game Accessory Sheet.)



50 STATES CARDS

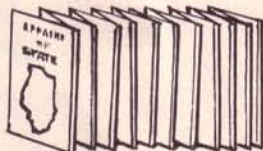

AFFAIRS OF STATES (ANSWER FOLDER)



STATES STUDY MAP

(Please note: So that a greater playing area can be viewed, Hawaii and Alaska have been placed at the lower left—on the Overlay and on the Study Map.)



A

## SET UP

1. Insert GAME CARD #6 into the Master Control Unit.
2. Place the STATES Overlay on the screen.
3. (Illust. A). Place the "GREAT LAKES BONUS" (from Game Accessory Sheet) onto the overlay, as illustrated. Note: Leave it affixed permanently—do not remove it from the overlay.
4. (Illust. B). Arrange the STATES CARDS into matching color groups.



PURPLE



MAGENTA



RED



YELLOW



GREEN



BLUE

B

## PLAY

Decide who will be the first CHALLENGER (the one to answer first). Only the Player Control #2 is used in the States game. Its electronics are "shuffled" by





C



D

the CHALLENGER'S opponent. The CHALLENGER depresses and holds the Player Control #2 RESET Button down while offering the VERTICAL and HORIZONTAL controls to his opponent, who must have his eyes closed. His opponent turns the HORIZONTAL Control and the VERTICAL Control to random positions, thus "shuffling" the electronics. The CHALLENGER then tells his opponent to open his eyes as he releases the RESET Button. The light marker will float onto the screen. (Illustr. C). When it stops, the CHALLENGER tries to identify the state (or states) the light has landed on. His answer is verified by finding the card for the state he has landed on. (A light dot will designate the state). He then turns the card(s) over to see if his answer is correct.

If the CHALLENGER correctly names the state or states, he receives that state card (or cards). If a light falls on the overlay, but is outside any of the states, the CHALLENGER may use either his HORIZONTAL or VERTICAL Control to move his light to the first unclaimed state. (Illustr. D). If he correctly identifies the state, he gains possession of that state card. It is now the other player's turn to become CHALLENGER, and the electronics of the Player Control are "re-shuffled."

When the CHALLENGER lands on a state already won by his opponent, he issues a challenge to his opponent for ownership of that state. The state owner asks the CHALLENGER *one* of the questions from that state card. (They may be asked in any order). If the CHALLENGER *answers correctly*, he gains possession of the state card from his opponent. The answers are in the "AFFAIRS OF STATE" folder.



E

PLAYER HAS LIT UP A FISH IN ONE OF THE GREAT LAKES.

## GREAT LAKES BONUS

If the CHALLENGER catches a fish in the Great Lakes, and correctly names the lake, he gets to go fishing for a Free State from the deck of states cards. (A fish is caught when a circle in one of the Great Lakes is lit by the CHALLENGER'S light). (Illustr. E). The Free State card is permanently owned and is not subject to challenge for the duration of the game. The winner is the Player who has the most state cards after all 50 States have been taken.

Game Variations: First one to win . . .

- A. 35 States
- B. 25 States
- C. 15 States



# SIMON SAYS

...a fun game for pre-schoolers that develops hand and eye coordination, and helps children learn to identify parts of the body with the associated printed word. (For 2 or 3 players)

## GAME AIDS

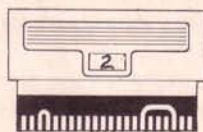

GAME CARD #2



GAME OVERLAY



28 SIMON SAYS CARDS

## RULES FOR THREE PLAYERS

### SET UP

1. Insert GAME CARD #2 into the Master Control Unit.
2. Place the "SIMON SAYS" Overlay on the screen.
3. Players select one figure (Boy or Girl) and they *must* maneuver their light on that figure throughout the game.
4. (Illust. A). Each player moves his light to his box, as illustrated.
5. The "Simon Says" cards are then shuffled and placed in front of the third player, who is "SIMON."



A

### PLAY

(Illust. B). SIMON turns over the first card from the deck and announces, "Simon Says, go to your elbow." Player one and player two go to their elbows. The first player to reach the elbow, wins the "elbow" card. If SIMON determines that there is a tie, the card is placed at the bottom of the deck.

If "SIMON" does not say "Simon Says," the players are not to move. If a player *does* move, he must return a "Simon Says" card to the deck. Play continues until the entire deck has been used.

The player who collects the most cards wins the game.



B

## RULES FOR TWO PLAYERS

Two players alternate turning the cards. At the count of three, they race their lights for the position indicated by the card that has been turned over. The player who arrives first wins the card. If there is a tie, the card is placed at the bottom of the deck. The player who collects the most cards wins the game.



## PERFORMANCE CHECK LIST

Should your ODYSSEY System appear to be malfunctioning, this Performance Check List will help you determine if service is actually required.

1. If you do not get a player image on your television screen when a Game Card is inserted in the Master Control Unit . . .
  - A. Rotate the HORIZONTAL and VERTICAL controls on both Player Control Units. If the player images do not appear on the screen, continue with the check list.
  - B. Check to see that the Channel Selector on your television is set to the proper channel, as indicated by the Channel Switch in your Master Control Unit. (See page 4).
  - C. Check to see that the Game Card is inserted properly with the number facing outward and is plugged in all the way.
  - D. Check to see that the slide on the Antenna-Game Switch is in the "Game" position and that the Antenna-Game Switch has been properly installed.
  - E. Check to see that the Game Cord is plugged into the socket provided on the top of the Antenna-Game Switch and on the back of the Master Control Unit.
  - F. Check the batteries in your Master Control Unit to see that they are properly installed. Also, if your game has been in operation for some time, the batteries may be weak and should be replaced.

2. If the display on your television screen is distorted or scrambled, then the problem may be an adjustment of the television controls . . .

- A. Check to be sure you are on the proper channel for game operation.
  - B. Switch the television to a known operating local station and the Antenna-Game Switch to the TV position. Adjust the television controls as necessary to obtain a normal picture.
  - C. If a normal picture is obtained, switch back to the game position and set your television to the proper channel on which ODYSSEY is used. Adjust the VHF Fine Tuning on the television.
3. If you experience trouble with only one game . . .
    - A. Check your game instructions to be sure you have the proper Game Card and that it is properly inserted in the Master Control Unit.
    - B. Check your Game Card to see if there is any visible damage to the card.

## ADDITIONAL GAMES AND GAME MATERIALS

Should an Overlay or Game Card become damaged or misplaced, contact your local Magnavox dealer for replacements.

Your Magnavox dealer will also have available an assortment of additional ODYSSEY games. Each game will have the necessary Game Card, Overlay, and Game Aids required for play.

## WARRANTY

Magnavox warrants its ODYSSEY™ electronic game simulator to the original purchaser to be free from defects in materials and workmanship for three months from date of purchase and under the following conditions:

Inoperative in-warranty ODYSSEY systems (Master Control Unit, two Player Control Units, Antenna-Game Switch, Game Cord, and Game Cards) must be delivered to the selling Dealer for his inspection. Any system found to be de-

fective will be replaced with a new one.

Replacements furnished during the warranty period are guaranteed for the balance of the applicable warranty.

This warranty applies when the product is subjected only to normal use and purchased from a franchised Magnavox Dealer in the United States or Canada. Furthermore, this warranty does not cover the batteries nor does it extend to a system which has been modified or damaged.

**SERVICE:** For Out-of-Warranty repair information, contact your Magnavox Dealer.



A TOTAL PLAY  
AND LEARNING EXPERIENCE  
FOR ALL AGES

# ODYSSEY

By

**Magnavox**