

Welcome to the World of PlayStation

Get your PS4 up and running with this handy Quick Start Guide.



Quick Start Guide

English

CUH-1002A / CUH-1003A

Getting started

1 Connect to your TV.

Follow steps 1 to 4 below to connect your PlayStation®4 system to your TV.

Rear view

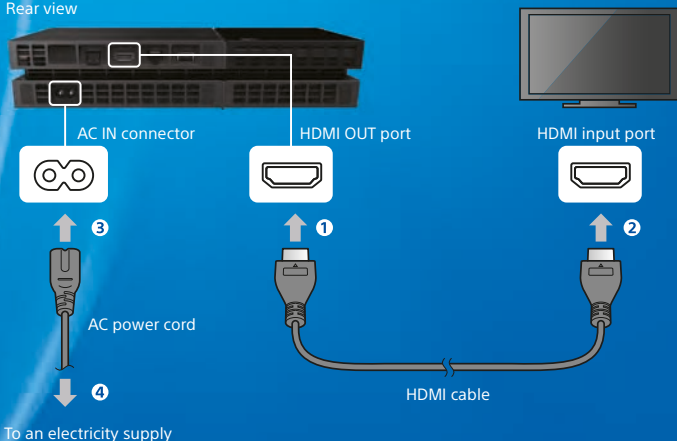

Using a PlayStation®Camera? Find out how to set it up in its instruction manual.



2 Connect to a LAN cable (sold separately).

No Wi-Fi connection? You can use a LAN cable to connect your PS4™ system to the Internet instead.

To connect your PS4™ system to the Internet via Wi-Fi, do not connect a LAN cable.

Rear view

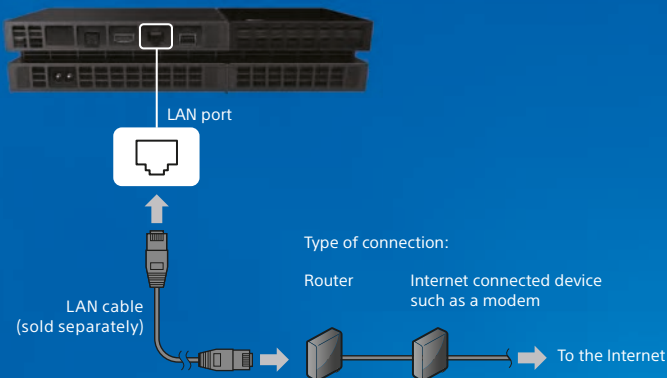



We recommend connecting your PS4™ system to the Internet to get the most out of it.

3 Turn on your TV, and then change the TV channel to HDMI™.

4 Turn on your PS4™ system by touching the  (power) button.

The power indicator will blink  blue, before turning  white.



If you can't get a picture when the PS4™ system is turned on (the power indicator will turn  white), simply touch the  (power) button for at least 7 seconds (until the system beeps twice) to turn off the power, and then turn on the power again.



5 Connect your DUALSHOCK®4 wireless controller to your PS4™ system using the USB cable, and then press the  (PS) button.

The controller will be registered (paired), and turn on.

Front view

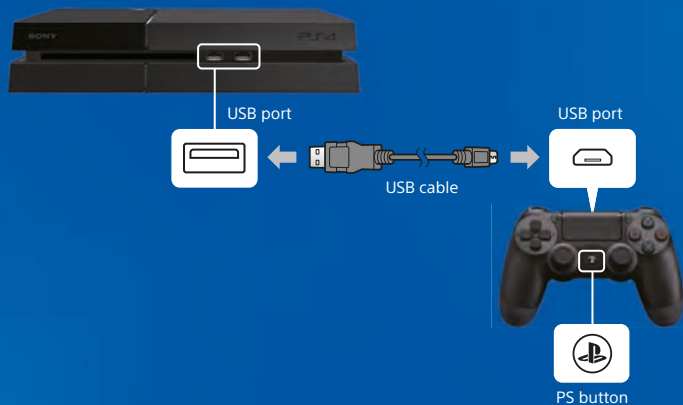

- You'll need to register (pair) the controller in some situations, such as when you use the controller for the first time, or when you use the controller on another PS4™ system.
- Once you've registered (paired) the controller, you can disconnect the USB cable and use the controller wirelessly.

6 Select your settings.

Set up an Internet connection, set the date and time, and adjust other settings. Follow the on-screen instructions to adjust various settings, and then select [Start Now] from the set-up completion screen.

Once you have set up an Internet connection, a system software update will be downloaded automatically - as will future system software updates.

Will a child be using your PS4™ system? If so, be sure to read “Setting the parental control” section.

You can change any settings that you previously skipped via  (Settings) or [Profile] in the function screen.



Setting the parental control

Some PS4™ content may not be suitable for your child. Most PS4™ content is rated by an independent ratings body.

To ensure your child only has access to suitably rated content, just set the correct parental control before you first let your child play. You can set the parental controls in  (Settings) in the function screen > [Parental Controls] > [Restrict Use of PS4 Features] > [Application]. Use the tables below for guidance on how the Parental Control Setting relates to different age groups.

You can restrict access to Blu-ray Disc™ and DVD video content, and to the Internet Browser, from  (Settings) in the function screen > [Parental Controls] > [Restrict Use of PS4 Features]. Restricting access to the Internet Browser will not prevent launch of some applications that use the Internet.

Regardless of the Parental Control Settings, you should monitor your child's activity on the PS4™ system. You can override the Parental Control Settings at any time to allow an older child or adult to play.

Europe, Africa and India

Player's Age	Under 3	3-6	7-11	12-15	16-17	18 and over
PS4™ Parental Control Setting	1	2	3	5	7	9
Highest game age rating						

Australia

Player's Age	Any	0-14	15-17	15-17	18 and over
PS4™ Parental Control Setting	1	3	7	8	9
Highest game age rating					

New Zealand

Player's Age	Any	0-12	13-15	16 and over
PS4™ Parental Control Setting	1	3	7	9
Highest game age rating			 	 

For more information on parental controls and age ratings please visit eu.playstation.com/parents or go to the Settings section of the User's Guide.

SONY



COMPUTER
ENTERTAINMENT ©



4-474-513-81(1)

© 2013 Sony Computer Entertainment Inc. All rights reserved.
Printed in China

SONY®

Using the screen

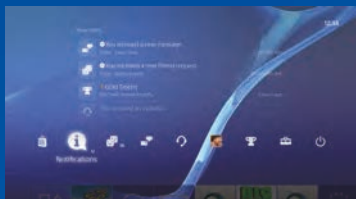

Function screen

Access several features here including your current Trophy details, new notifications, Friends and Settings.

To enjoy some features, you must have an Internet connection or be signed in to PSNSM.



Up button/
Down button



Home screen

Content area

Access your games and other content. All content is listed from left to right in order of the most recently accessed.



Up button/
Down button



Content info screen

Access the latest information about the currently selected content. To display the latest information, you must be signed in to PSNSM.

Playing games

1 Insert a disc.

The game will appear in the content area of the home screen.

Front view



2 Select the game to start playing.



Quitting a game

Press and hold the **(PS)** button, and then select [Close Application].

Returning to the home screen from a game

To return to the home screen without quitting a game, press the **(PS)** button.

To resume playing the game, select it from the content area.

Removing a disc

Touch the **(Eject)** button.

Front view



Eject button

Go to (PlayStation®Store)

Now that you've got a PS4™ system, it's time to head over to see what's available at PlayStation®Store.

PlayStation®Store has a wide variety of downloadable content, some of which you can't get anywhere else. You'll find games to suit every taste, as well as game add-ons that make your games even more fun to play, plus free demos and much, much more. And you can even begin playing your games before they've finished downloading.

To use PlayStation®Store, you must have a Sony Entertainment Network (SEN) account and an Internet connection. PlayStation®Store and SEN subject to terms and country and language restrictions, see eu.playstation.com/legal for details. Users are responsible for internet service fees. Users must be 7 years or older and users under 18 require parental consent. Additional age restrictions may apply. Charges apply for some content and/or services.

Sharing your gaming experience

When using some of the PS4™ system's online services, you can upload screenshots and video clips of gameplay from a game, and broadcast (stream) your gameplay.

To use these features, you must have an SEN master account and an Internet connection.

Using a mono headset

Connect the mono headset to your controller for in-game voice chat.

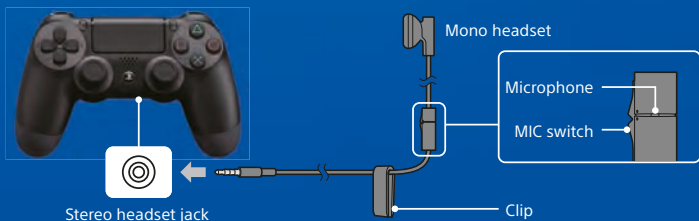

Creating an SEN account

Create an SEN account to use PSNSM and SEN services such as PlayStation®Store and Music Unlimited*.

* Not available in all countries.

- You can create your own SEN account for free.
- You must have an Internet connection to use services. You must also update the system software to the latest version.
- A maximum of 16 accounts can be registered on each PS4™ system.
- To create a sub account for users under a certain age, you must first create a master account for a parent or guardian.
- Accounts created on a PlayStation®3 system, a PlayStation®Vita system, or a computer can be used on the PS4™ system.

If you do not have an SEN account

Select  (Settings) > [PSNSM] > [Sign In to PSN] > [I don't have an account] from the function screen, and then create an account.

If you already have an SEN account



Select  (Settings) > [PSNSM] > [Sign In to PSN] from the function screen, enter your sign-in ID and password, and then select [Sign In].





Using the controller

Charging

To use your controller wirelessly, you must first charge its battery. Press and hold the  (PS) button and the controller's battery charge level will be shown on-screen.

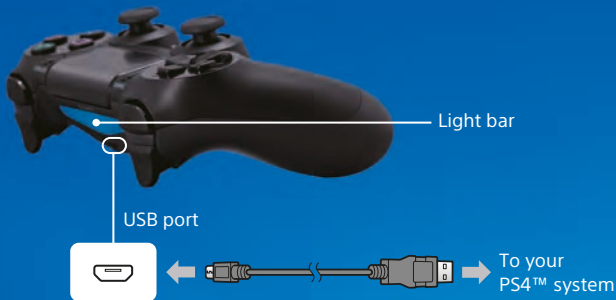
- 1** Turn on your PS4™ system (the power indicator will light up , or set it to standby mode (the power indicator will light up  orange).
- 2** Connect your controller to your PS4™ system with the USB cable.



To charge your controller when in standby mode, you must first checkmark the [Supply Power from USB Ports] option in  (Settings) > [Power Saving Settings] > [Set Functions Available in Standby Mode].

Using multiple controllers

You can use up to 4 controllers at the same time.

When you press the  (PS) button on a controller for which registration has been completed, a colour will be assigned to that user and the light bar will light up in their own colour, depending on the order in which they join in. The first user is blue, the second is red, the third is green and the fourth is pink.





Turning off the power

Caution

If you disconnect the AC power cord while the power indicator is lit or blinking, data might be lost or corrupted, or the system might become damaged. You must disconnect the AC power cord only once the power is turned off completely. Be sure to read the "Turning off the power completely" section below.

Entering standby mode

You can charge the controller from a USB port and remain signed in to PSNSM while in standby mode.

Select  (Power) from the function screen, and then select [Enter Standby Mode]. The picture will disappear, and the power indicator will blink  white, before turning  orange.



To exit standby mode, press the  (PS) button.

Turning off the power completely

Select  (Power) from the function screen, and then select [Turn Off PS4].



The picture will disappear, and the power indicator will blink  white, before turning off.

Power indicator status

 White	The power is on
 Orange	Standby mode
Unlit	The power is off

Further information

User's Guide

The User's Guide contains more information about what your PS4™ system can do – including how to adjust settings, how long to charge the controller for and how to use each function. Select  (Settings) >  (User's Guide) from the function screen.



You can also view the User's Guide by visiting:

eu.playstation.com/help/ps4/manuals/

You must have an Internet connection to view the User's Guide.

Safety Guide

The Safety Guide contains information about how to safely use your PS4™ system, and information about specifications. Be sure to read it before using the system.

"", "PlayStation", "DUALSHOCK", " and " are registered trademarks of Sony Computer Entertainment Inc. "PS4" and "PSN" are trademarks of the same company.

"SONY" and " are registered trademarks of Sony Corporation. "Sony Entertainment Network" is a trademark of the same company.

The terms HDMI and HDMI High-Definition Multimedia Interface, and the HDMI Logo are trademarks or registered trademarks of HDMI Licensing LLC in the United States and other countries.

"Blu-ray Disc™" and "Blu-ray™" are trademarks of the Blu-ray Disc Association.

Design and specifications are subject to change without notice.

Information about system functionality and images published in this document may vary from those for your system, depending on the system software version in use. Also, the illustrations and screen images used in this guide may vary from the actual product.