

# XaviX<sup>®</sup> PORT

a revolutionary way to interact with your TV

## USER'S GUIDE

## C O N T E N T S

---

The XaviXPORT Concept	2	██████████
Introducing XaviX Technology	4	██████████
The XaviX Concept — Advocating Change	6	██████████
<b>Precautions</b>	8	██████████
Health Precautions	11	██████████
Safety Precautions	12	██████████
Section 1 : Use and Handling of the XaviX AC Power Adapter and A/V Cable	12	██████████
Section 2 : Use and Handling of the XaviXPORT	13	██████████
Section 3 : Use and Handling of the System Cartridge	14	██████████
<b>XaviXPORT Package contents</b>	16	██████████
Welcome to the world of XaviX	17	██████████
Structure Description of XaviXPORT	18	██████████
How to Set up Your XaviXPORT	20	██████████
A/V Selector on the XaviXPORT	22	██████████
RF Connection Mode	23	██████████
Inserting a System Cartridge in the XaviXPORT	24	██████████
Releasing a System Cartridge from the XaviXPORT	25	██████████
<b>Troubleshooting</b>	26	██████████
<b>Owner's Record</b>	28	██████████
<b>XaviXPORT Specifications</b>	29	██████████
<b>Warranty</b>	30	██████████

# The XaviXPORT Concept

**XaviX<sup>®</sup>**  
You power.<sup>™</sup>



## **A revolutionary way to interact with your TV**

The XaviXPORT is your gateway to interactive activities powered by you. With XaviX Technology, you and your family can step up to your TV and experience your favorite activities like never before. From interactive sports and fitness to scientific discovery, with XaviXPORT your television experience will never be the same. How you interact with it is up to you. You power.



## A Wide Range of Fun Packed into a Slim Body

Connect XaviXPORT to your TV, and you'll see your TV instantly converted into Digital Entertainment Technology Gear! XaviXPORT is a completely innovative amenity tool that allows families everywhere to enjoy a wide selection of software content.

Connect XaviXPORT to any NTSC-compatible TV in your homes just like a part of the TV itself so that you can fully experience the fun and excitement that the XaviX System has to offer you.

# Introducing XaviX Technology™



### CONSTANTLY EVOLVING SOFTWARE AND HARDWARE

The processor contained in the XaviX System Cartridge, and software and hardware technology are steadily being upgraded. Software will create more fun and enjoyment for people, and hardware technology will fully bring out the outstanding characteristics of the software. As XaviX software and hardware evolves, we will be offering the very latest products.



### SYSTEM CARTRIDGE TECHNOLOGY

The XaviX System Cartridge contains the heart of the XaviX System – the advanced XaviX Processor. In some cases, it also holds a sensor that is ideally matched to the type of software. This ideal combination – XaviX Processor and state-of-the-art sensing technology – presents you with the very latest, exciting software content.



### MULTI-CHANNEL OPERATION ENABLED BY HIGH-SPEED INFRA-RED COMMUNICATIONS

The XaviXPORT incorporates a function for communicating with external equipment using infra-red rays. This allows people to move freely around your room without being tied up by cables. Also, human motion is captured in a multi-channel manner by high-speed communications, which means that two people can interact and enjoy XaviX software at the same time, for instance, in a game of doubles in XaviX Tennis.

### DEVELOPMENT POLICY

We are developing the XaviX System with a view to "providing consumers with cheap, high-performance products." The core concept of XaviX Technology is its focus on people. We believe that we have succeeded in achieving low cost and high performance in a communication tool that brings people closer together.

XaviX Technology transcends the realms of hardware and software. It turns man's universality and sensibilities into a science. We are working towards creating a technology that allows us "to sense humanity" at all times so that we can be a close presence to people in any age or time.

### Infra-Red Sensor

Catching Your Every Movement!

The XaviX Interface turns human motion into signals which are transmitted to the Infra-Red Sensor on the XaviXPORT. This movement is then translated into exciting and fun-filled action on your TV screen.





# Sit Back and Just Imagine!

# The XaviX Concept – Advocating Change



## The XaviX Concept – Advocating Change

Though it may be wishful thinking, if the world of Man could avert war and oppression, and abandon foolishness, there would be no borders between people in countries around the world and there would there be a single future for everyone. People would always be searching for the truth, enriching their knowledge, and never forget compassion for fellow man. On top of that, they would be able to solve things by means they had never thought possible. If only this could be the world to come.

## Now, just imagine if XaviX could accelerate the arrival of that world.

XaviX would unconsciously remove these borders placed around us – borders between people, man and machines, and dreams and reality. This would bring everyone in the world together, and for the first time our lives and awareness would probably change anew. And doing all of this would be XaviX.

In line with this basic philosophy, XaviX values "human science." At the same time, XaviX continually searches for new possibilities, continues to pursue and challenge new horizons, and continues to propose a new living environment for people.

If our products could be a wonderful tool for communications between people, and could foster and strengthen human bonds. If they could transcend race and borders, and make more and more people smile.

This wish – to bring happiness to people – is our ultimate mission.

# PRECAUTIONS

## FCC Rules for customers in the U.S.A.

- XaviX products have been tested and found to comply within the limits for a Class B digital device, pursuant to Part 15 of the FCC rules.
- These limits are designed to provide reasonable protection against harmful interference in a residential installation.
- XaviX products generate, use and can radiate radio frequency energy and, if not installed and used in accordance with instructions, may cause harmful interference to radio or television reception, which can be determined by turning the product off and on. The user is encouraged to try to correct the interference by one or more of the following measures:
  - Reorient or relocate the receiving antenna.
  - Increase the separation between the product and receiver.
  - Connect this product into an outlet on a circuit different from the circuit to which the receiver is connected.
  - Consult the dealer or an experienced radio/TV technician for help.

## Declaration of FCC conformity

- This product complies with Part 15 of the FCC Rules. Operation is subject to the following two conditions: (1) this product may not cause harmful interference, and (2) this product must accept any interference received, including interference that may cause undesired operation.
- FCC/CSA regulations state that any unauthorized changes or modifications to this product may void your Warranty and your authority to use it.



### CAUTION

#### RISK OF ELECTRIC SHOCK. DO NOT OPEN

TO REDUCE THE RISK OF ELECTRIC SHOCK, DO NOT REMOVE COVER (OR BACK). NO USER SERVICEABLE PARTS INSIDE. REFER SERVICING TO QUALIFIED SERVICE PERSONNEL.

#### Symbols Used in This User's Guide



This symbol alerts the user to the risk of high voltage inside this equipment. Contact with high voltage may cause an electric shock.



This symbol alerts the user to important operating and maintenance (servicing) instructions in this Precaution Guide.



This symbol alerts the user to actions that he or she should not do when handling XaviX products. Mishandling XaviX products in the way shown in illustrations marked with this symbol may cause malfunction, damage, accident or injury.



This symbol indicates actions that the user should take when handling XaviX products.

For use in North America only.

#### Caution to Owners of Projection TVs

- Some televisions, especially front and rear projection televisions, can be damaged through the use of video games, including the XaviX system. For example, images projected on some televisions may cause "burn-in" or permanent shadows of static images to appear on the TV screen.
- Consult your television user's manual to determine if the system can be played safely on your TV set. If you are unable to find this information in the user's manual, please contact your television dealer or manufacturer to determine if the XaviX system can be played safely on your TV set.

#### Use with NTSC TVs

- Use the XaviXPORT only with NTSC TVs. Do not use the XaviXPORT with PAL system TVs.



#### Health Precautions

The following cautions are for the protection of your health. **Read them carefully** before you and your family start to enjoy the XaviX System.

#### Caution for Seizures

- A very small percentage of individuals may experience epileptic seizures when exposed to certain light patterns or flashing lights. Exposure to certain patterns or backgrounds on a television screen or while playing video games, including XaviX software, may induce an epileptic seizure in these individuals. Certain conditions may induce previously undetected epileptic symptoms even in persons who have no history of prior seizures or epilepsy.
- We recommend that people who have had seizures or blackouts consult a doctor before they use this product.
- You can reduce the possibility of seizures or blackouts by:
  - Standing as far away as possible from your TV screen.
  - Adjusting or reducing the contrast, brightness and color level on your TV to a comfortable level.
  - Operating the product in well-lit room conditions.
  - Taking a **10- to 15-minute** break or not using this product if you feel tired or sleepy.
  - If you feel dizzy or nauseous during use of this product, immediately stop using it, and take a rest until you feel better.
- Keep a careful watch over your child(ren) while they use this product.



### Safety Precautions

XaviX products have been designed with the utmost consideration placed on safety. Failure to abide by the following warnings and instructions can result in serious injury or death from electric shock or fire, or damage to XaviX products or other property.

#### Section 1 : Use and Handling of the XaviX AC Power Adapter and A/V Cable

The XaviX AC Power Adapter and A/V Cable are provided for the XaviXPORT only.

Use **only** the Power Adapter provided with the PORT.  
Do **NOT** use other adapters to connect to the PORT.

Do **NOT** connect the Power Adapter to other electrical devices.

The Power Adapter provided is compatible with 120 VAC (60 Hz) electrical systems that are Underwriters Laboratories (UL) approved.

Do **NOT** plug the Power Adapter into other power outlets conforming to other electrical systems.

Do **NOT** push or insert anything into openings.

When inserting the Power Adapter plug into a **multi-plug strip**, make sure that the outlet is **NOT overloaded**.

Keep the Power Adapter and A/V Cable away from water, liquid or moisture.

Do **NOT** touch the Power Adapter and A/V Cable with wet hands.

Before you connect the Power Adapter to an outlet, be sure to **unwind** the cable.

**Never** subject the Power Adapter and A/V Cable to **unnecessary stress** and **shock**.

Do **NOT** use the Power Adapter and A/V Cable if their cables are **split** and **broken**.

Keep small child(ren) and pets away from the Power Adapter and cables.

- Do not jerk, knot, sharply bend, or otherwise abuse the A/V Cable or cord for the Power Adapter.
- Do not expose the A/V Cable or Power Adapter to sources of heat.
- When unplugging the Power Adapter or A/V Cable, always pull on the plug - do not pull on the cord.

#### Section 2 : Use and Handling of the XaviXPORT

The XaviXPORT is the platform unit for connecting to a TV so that you can enjoy the XaviX system.

Do **NOT** touch the System Slot located inside the PORT with your fingertips, metal pins or other objects.

Do **NOT** insert wire, metal pins or other objects into the Jacks or Ventilation Holes on the rear and side panels.

Do **NOT** dismantle the PORT for servicing or repair yourself, or insert anything into openings.

Keep the Ventilation Holes on the right side panel free.

Do **NOT** stick any labels over them or block them.

**Locate** the PORT on a **flat, stable surface** around your TV. (Please refer to the User's Guide for each XaviX product as the best installation location varies with each product.)

**Never** block the Infra-Red Receiver from receiving signals transmitted by the Interfaces.

**Make sure** that the plug on the Power Adapter and A/V Cable are **fully inserted** into the A/V OUT and the POWER IN on the PORT.



**Keep away** from water, liquid and moisture.

To **clean** off dirt or stubborn stains, wipe gently with a soft dry cloth. Do **NOT** use a cloth moistened with alcohol, benzene or other organic solvent.

Do **NOT** press down hard on the stage or touch the Jacks and System Slot when cleaning.

- Make sure that the PORT is **turned off** after you have finished using it.
- If you notice or suspect that there is a loose object inside the XaviXPORT, immediately discontinue all use of the PORT and unplug the PORT from the power outlet.
- Always unplug the XaviXPORT from the power outlet before connecting or disconnecting it to/from a TV, VCR or other A/V device.
- Do not use attachments, peripherals or other devices with the XaviXPORT that are not specified and either licensed or distributed by SSD COMPANY LIMITED for use with the XaviXPORT.

### Section 3 : Use and Handling of the System Cartridge

The System Cartridge is packed together with the XaviX Interface as an integral part of the XaviX System. The System Cartridge is inserted into the XaviXPORT.

The System Cartridge Blade is for connecting to the System Slot on the PORT.

Do **NOT** touch this System Cartridge Blade with your fingertips, or insert wire, metal pins or other objects into this System Cartridge Blade.

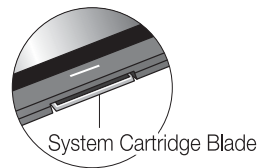

Do **NOT** dismantle the System Cartridge for servicing or repair yourself, or insert anything into openings.

Make sure that the alignment mark on the System Cartridge for the **correct position** of the Cartridge is aligned with the inside wall of the PORT

Place the System Cartridge on the PORT at the **correct location** and **orientation**.

**Follow** the instructions in the User's Guide to release the System Cartridge from the PORT correctly.

Do **NOT** insert any objects into the PORT to release the System Cartridge.







**Keep away** from water, liquid and moisture.

To **clean** off dirt or stubborn stains, wipe gently with a soft dry cloth. Do **NOT** use a cloth moistened with alcohol, benzene or other organic solvent.

Do **NOT** attempt to install, insert or connect other tapes or a **non-System Cartridge** in or to the PORT.

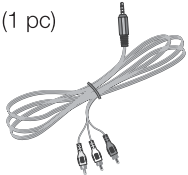
### XaviXPORT Package contents

Open your package and check that you have the following:

PORT (1 pc) 	
Power Adapter (1 pc) 	A/V cable (1 pc) 
User's Guide (1 pc) 	Quick Setup Guide (1 pc) 
Registration Card (1 pc) 	Serial No. Label (4 pcs) 

- The XaviXPORT does not use batteries.
- Stick the Serial No. Label on the under side of the XaviXPORT , the Registration Card and the User's Guide. Otherwise, the Warranty is void if any problems occur. (The Serial No. seal and Registration Card are included in the package.)
- About the Power Adapter
  - Use only the Power Adapter included in the package.
  - Do not use the AC Power Adapter on other electrical devices and appliances.
  - Do not use power adapters made by other manufacturers for other electrical devices and appliances.

### Welcome to the World of XaviX

Thank you for purchasing your XaviXPORT and/or XaviX system. Before using this product, please read this guide carefully for safe and proper use, set up and care for your XaviXPORT and/or XaviX System. After you have finished reading this guide, keep it in a safe place for future reference.

Please refer to the table below for trademarks and terms used to describe this products.

Trademark	Terms
XaviX®	XaviX or XaviX Processor
XaviXTechnology™	XaviX Technology
XaviX®PORT	XaviXPORT or PORT
XaviXSystemCartridge™	XaviX System Cartridge or System Cartridge
XaviXInterface™	XaviX Interface
XaviX® AC Power Adapter	Power Adapter
XaviX® A/V Cable	A/V Cable

"XaviX," and certain other trademarks and logos listed above or appearing in this User's Guide, are registered trademarks or trademarks of SSD COMPANY LIMITED in the United States and other countries.

### Structure Description of XaviXPORT

Before you connect your PORT to your TV or AV equipment, look at the picture below and make sure that you are familiar with:

- The various parts of the PORT
- What these parts are for.

#### FRONT VIEW

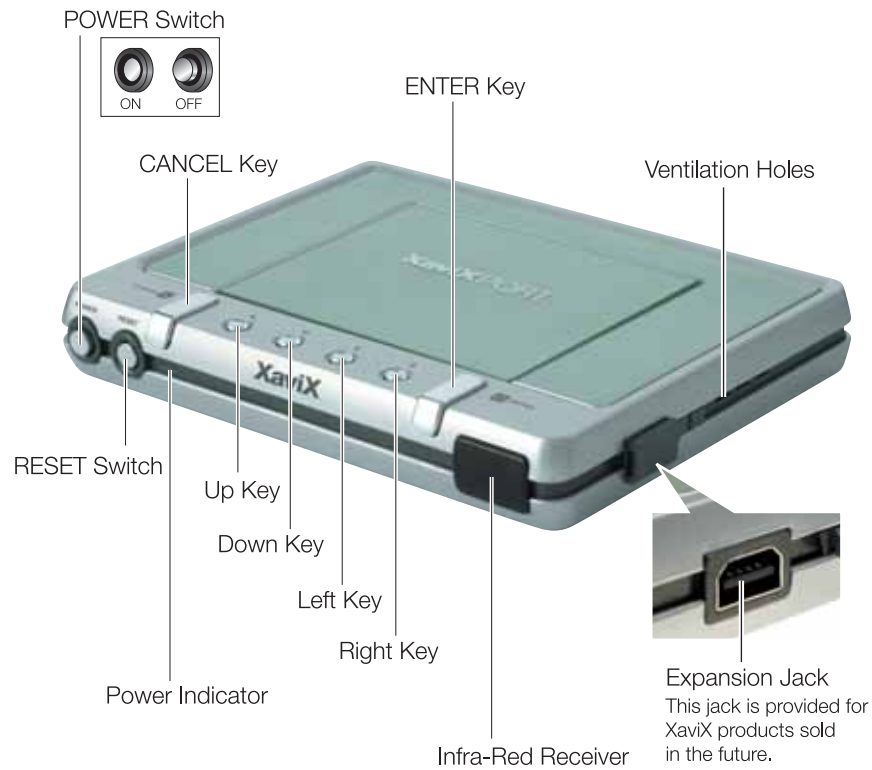

#### REAR VIEW

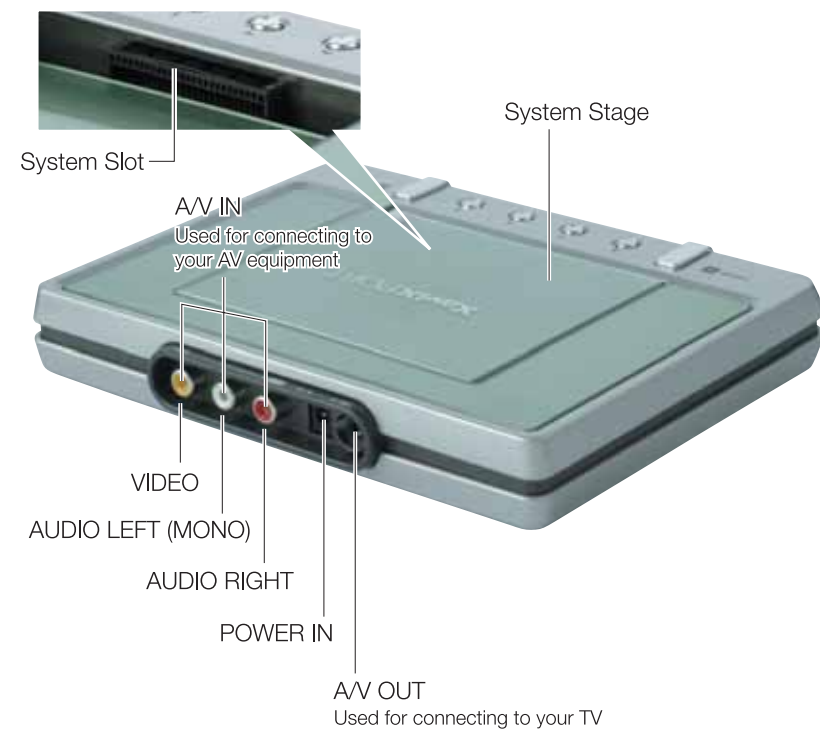

### How to Set up Your XaviXPORT

Be sure to thoroughly read and understand this section before you connect your XaviXPORT.



#### CAUTION

Before you connect the PORT to your TV, make sure that you turn off your PORT and follow the sections below for your connection options.

### Connecting to your TV

1. Connect the Mini-plug of the A/V Cable to the Jack of A/V OUT on the rear of the PORT.
2. Connect the color A/V Plugs on the other side of A/V Cable to the AV input jacks on your TV. The colors of the A/V Plug are defined as follows:

Yellow	Video
White	Audio (Left/Mono)
Red	Audio (Right)



#### Note

Make sure the plugs have been inserted as far as they can go. If your TV is monaural, use the White Plug to connect to audio input on your TV. The position where jacks are provided on your TV differs with each type of TV. For details, refer to your TV user's manual.

3. Plug the Power Adapter into the power outlet. Make sure that the outlet conforms to a 120 VAC (60 Hz) system.
4. Connect the plug at the Power Adapter to POWER IN on the rear of the PORT.
5. Insert the System Cartridge in the PORT. (Please refer to the User's Guide for each XaviX system.)
6. Turn on the TV and select the required AV channel on your TV.

7. After pressing the PORT POWER Switch, the Power Indicator will turn on, and the XaviX Logo and opening sound will come out of your TV.



#### CAUTION

Please be sure that the A/V mini-plug is firmly inserted into the back of the XaviXPORT.

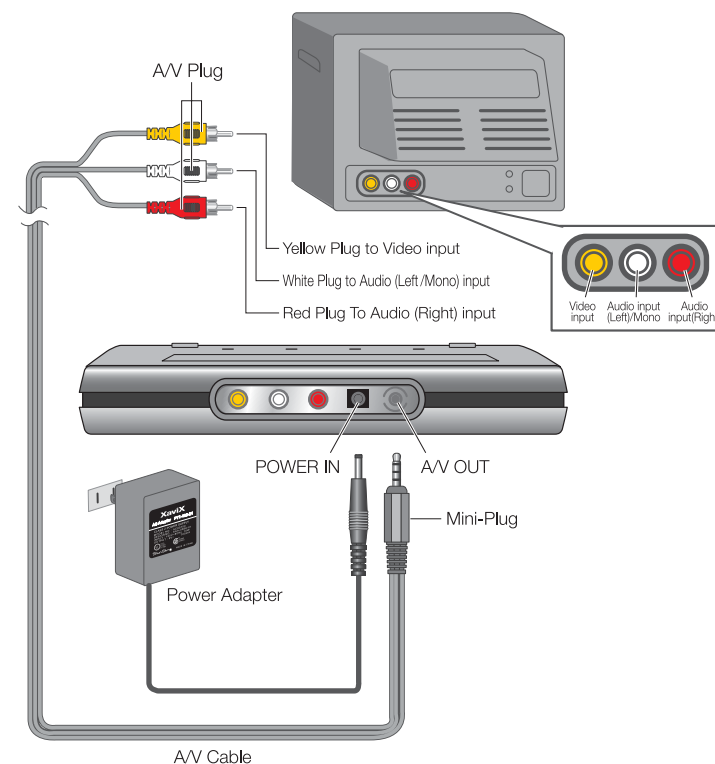

#### Note

Nothing will come out of your TV if the System Cartridge is not inserted in the PORT, or if the System Cartridge is inserted incorrectly.

### A/V Selector on the XaviXPORT

The PORT has an A/V selector function that uses A/V IN. This allows you to connect external AV equipment (e.g. VCR, DVD player or game console) to your TV via the PORT.

#### How to access the A/V Selector Mode on the PORT

- Regardless of whether or not the Power Adapter is connected, when the PORT is off, screen and sound from the AV equipment connected to the PORT are displayed on your TV.
- Phrased differently, when the PORT is on, screen and sound from System Cartridge are displayed on your TV.

#### A/V Selector Connection Mode

This allows you to connect external AV equipment via the PORT to your TV, if the AV inputs are fully occupied on your TV.

### A/V Selector Connection Mode with AV Equipment

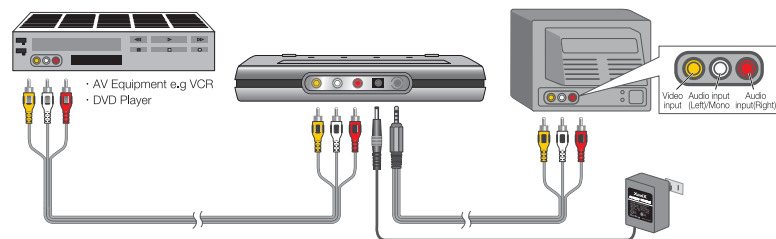

#### Connect the PORT to your TV

- Connect the Mini-Plug of the A/V Cable to the Jack of AV OUT on the rear of the PORT.
- Connect the color A/V Plugs on the other side of the A/V Cable to the AV input jacks on your TV.

#### Connect your AV equipment to the PORT

- Connect the AV cable (not provided) to A/V IN on the PORT and AV output jacks on your AV equipment.

#### Note

If your AV equipment is monaural, connect to the white (Audio Left/MONO) jack.

#### Recording Connection Mode

This allows you to record the screen and sound from the XaviX system via a VCR connection.

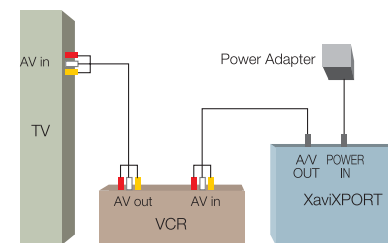

#### RF Connection via Stereo VCR

This allows you to connect the PORT to your TV via an antenna signal (RF signal) connection between the TV and a VCR with stereo audio inputs. Consider this option if your TV does not contain any AV input jacks.

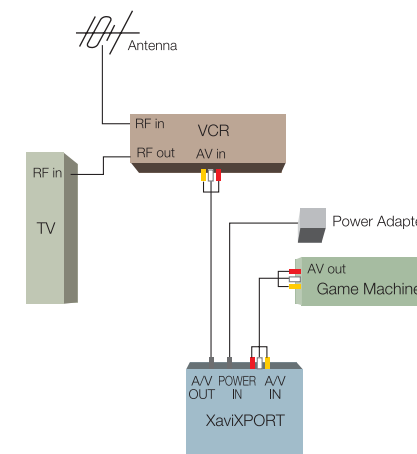

#### RF Connection via Monaural VCR

This allows you to connect the PORT to your TV via an antenna signal (RF signal) connection between the TV and a VCR with a monaural audio input. Consider this option if your TV does not contain any AV input jacks.

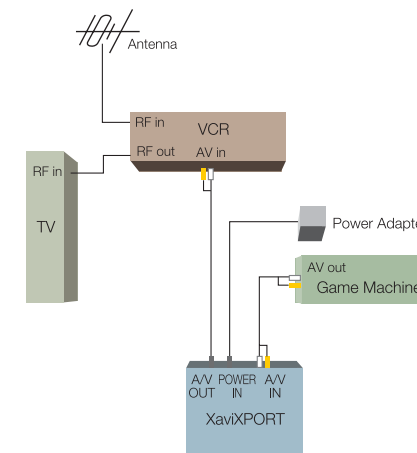

### Inserting a System Cartridge in the XaviXPORT

To start using a XaviX software package, you must insert the System Cartridge into the PORT (The PORT is sold separately).

**Note**

Before you insert the System Cartridge in the PORT, make sure that your PORT is turned off.  
Place the System Cartridge on the PORT at the correct location and orientation. (The System Cartridge Blade must face the front panel of the PORT.)

**Procedure:**

- A. Place the System Cartridge on the System Stage at the top surface of the PORT.
- B. Press down gently on the System Cartridge.
- C. Slide towards you until the alignment mark on the System Cartridge is on the position with the PORT.

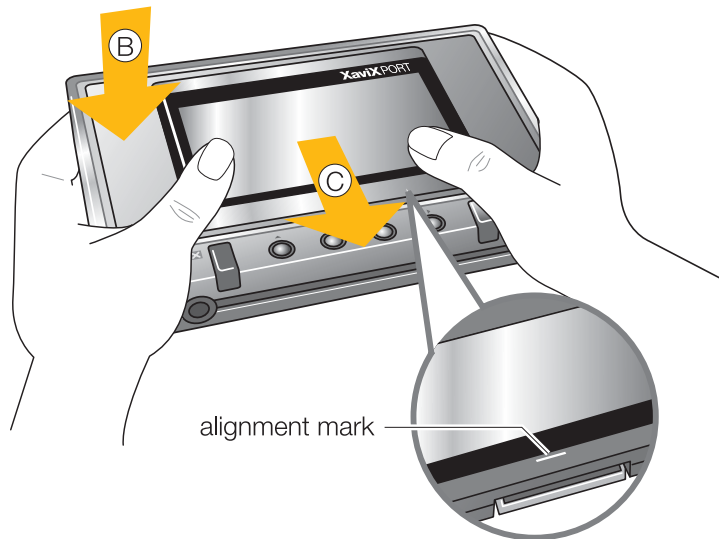

### Releasing a System Cartridge from the XaviXPORT

**Note**

Before you release the System Cartridge from the PORT, make sure that your PORT is turned off.

**Procedure:**

- D. Press down gently with your fingers on both sides of the System Cartridge and slide the System Cartridge in the direction labeled "D" below.
- E. Release your fingers. The System Cartridge will raise up automatically from the System Stage on the PORT.

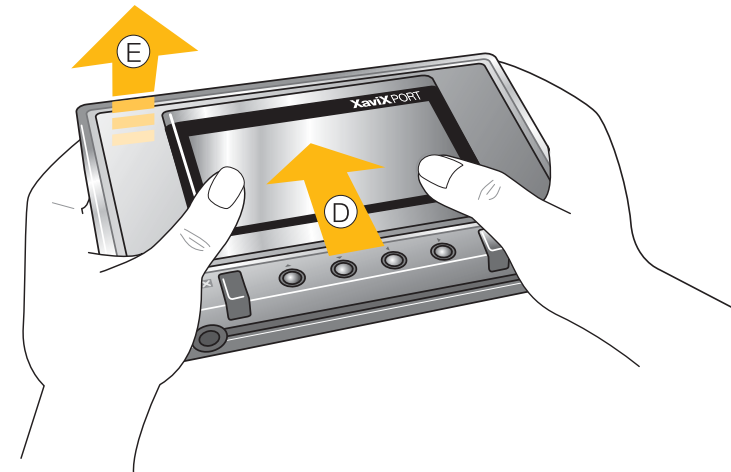

### Troubleshooting

Check the following before calling for service.

Problem	Check
<b>Power is not turned on.</b> (POWER Indicator light is not on.)	Make sure that the Power Adapter is securely plugged into an AC outlet and POWER IN on the rear panel of the PORT. Check that the POWER Switch of the PORT is turned on. (Refer to pages 18 and 19 of this User's Guide.)
<b>No picture on TV screen and no sound</b> (POWER Indicator light is on.)	Make sure that you are using an NTSC TV and it is turned on. Adjust the brightness and the contrast of your TV. Check that the required video input on your TV is selected. (Refer to your TV User's Guide.) Check that the System Cartridge is inserted properly into the Cartridge Slot on the PORT. (Refer to pages 24 and 25 of this User's Guide.) Check that the A/V Cable is connected securely to the appropriate jacks of the PORT and TV: <ul style="list-style-type: none"> <li>• The yellow plug of the A/V Cable must be inserted into the Video input jack on your TV</li> <li>• The red plug of the A/V Cable must be inserted into the Audio Right (AUDIO-R) input jack on your TV.</li> <li>• The white plug of the A/V Cable must be inserted into the Audio Left (AUDIO-L) input jack on your TV.</li> <li>• The Mini-Plug must be inserted into the A/V OUT on the rear panel of the PORT (Refer to pages 20 to 23 of this User's Guide.)</li> </ul> Check the brightness or volume setting on your TV. If it is set to zero, turn up the level. (Refer to your TV User's Guide.)
<b>Poor picture quality</b>	Make sure that you are using an NTSC TV. (Refer to your TV User's Guide.) Check that the yellow plug of the A/V Cable is inserted securely into Video input Jack on your TV and the other side of the Mini-Plug is securely inserted into the A/V OUT on rear panel of the PORT. (Refer to pages 20 to 23 of this User's Guide.) Remove the System Cartridge from the PORT, then insert it again. (Make sure that the PORT is turned off before removing the System Cartridge.) (Refer to pages 24 and 25 of this User's Guide.)

Problem	Check
<b>Poor picture quality</b>	Press the RESET Switch, then try again. (Refer to page 18 of this User's Guide.)
<b>Poor sound quality</b>	Make sure that you are using an NTSC TV. (Refer to your TV User's Guide.) Make sure that the A/V Cable is connected securely to the appropriate jacks of the PORT and your TV: <ul style="list-style-type: none"> <li>• The red plug of the A/V Cable must be inserted into the Audio Right (AUDIO-R) input jack on your TV.</li> <li>• The white plug of the A/V Cable must be inserted into the Audio Left (AUDIO-L) input jack on your TV.</li> <li>• The Mini-Plug must be inserted into the A/V OUT on the rear panel of the PORT (Refer to pages 20 to 23 of this User's Guide.)</li> </ul> Remove the System Cartridge from the PORT, then insert it again. (Make sure that the PORT is turned off before removing the System Cartridge.) (Refer to pages 24 and 25 of this User's Guide.) Press the RESET Switch, then try again. (Refer to page 18 of this User's Guide.)
<b>System Cartridge is not inserted.</b>	Make sure that the location and orientation of the System Cartridge is correct. (Refer to page 24 of this User's Guide.)
<b>PORT does not work. (Keys do not function.)</b>	Remove the System Cartridge from the PORT, then insert it again. (Make sure that the PORT is turned off before removing the System Cartridge.) (Refer to pages 24 and 25 of this User's Guide.) Press the RESET Switch, then try again. (Refer to page 18 of this User's Guide.)
<b>No picture and no sound from the AV equipment connected to A/V IN on the rear Panel of the PORT.</b>	Make sure that you are using an NTSC TV. (Refer to your TV User's Guide.) Make sure that the PORT is turned off while the AV equipment is used. (The Power Indicator on the PORT must be off.) (Refer to pages 22 and 23 of this User's Guide.) Make sure that the connections between the PORT and the AV equipment are correct.

Problem	Check
<b>No picture and no sound from the AV equipment connected to A/V IN on the rear panel of the PORT.</b>	<ul style="list-style-type: none"> <li>• One side of the yellow plug of the A/V cable must be plugged into the Video Output on the AV equipment and the other side of the yellow plug must be connected to A/V IN on the PORT.</li> <li>• One side of the red plug of the A/V cable must be plugged into the Audio Output (Right) on the AV equipment and the other side of red plug must be connected to the R Jack (Red Jack) of A/V IN on the PORT.</li> <li>• One side of the white plug of the A/V cable must be plugged into the Audio Output (Left) on the AV equipment and the other side of white plug must be connected to the L Jack (White Jack) of A/V IN on the PORT. (Refer to pages 20 to 23 of this User's Guide.)</li> </ul>

### Customer Support/Contact Information

- If you have any questions or experience any problems about this product, please read the details of This User's Guide and/or XaviX Products Precaution Guide, or call our Customer Support Hotline at 1-866-XaviXGo, write to XaviX Product Registration Department, P.O. Box 26490 San Diego, CA 92196-0490, U.S.A. or send an e-mail to [service@xavix.com](mailto:service@xavix.com)

### Owner's Record

The Serial No. of your XaviXPORT is written on the Serial No. Label. When you buy XaviXPORT, immediately stick one of the seals provided with your XaviXPORT Package on the under side of the PORT, and refer to this number when you call for assistance at the Customer Support Hotline indicated above.

Serial No.

### XaviXPORT Specifications

#### General

- Dimensions (approx.) : 182 × 137 × 28 mm (w/h/d)  
7.2" × 5.4" × 1.1" (w/h/d)
- Weight(approx.) : 300 g (0.66 lb)

#### Inputs/Outputs

- A/V OUT : 1
- A/V IN (A/V Selector) : 1 Video / Audio L + R
- Infra-Red Receiver : 1
- Expansion Jack : 1

#### Conditions

- Operating temperature: 5°C to 40°C (41°F to 104°F)

#### Other contents of the package

- XaviX AC Power Adapter : 120 VAC, 60 Hz (Input)  
9 VAC (Output)  
(UL approval)
- XaviX A/V Cable : 3 m (9.8 ft.)

#### Indoor use only

Design and specifications are subject to change without notice.

Unauthorized use or duplication of this document, in part or in whole, is prohibited and punishable to the extent permitted by applicable law.

Certain items described in this User's Guide are covered by patents, pending patents, trademarks, copyrights and/or other intellectual property rights of SSD COMPANY LIMITED (SSD). Except as expressly provided herein with respect to software, this User's Guide does not include any grant of a license or other right with respect to any patent, pending patent, trademark, copyright or other intellectual property right of SSD.

#### Patent Information

U.S. and other countries patents pending.

To the extent permitted by applicable law, all commercial use (including rental and leasing) and reverse engineering of XaviX products, and circumvention of copy protection, is prohibited. The software included in or with the XaviX products is licensed to you solely for use with the XaviXPORT and is not sold.

©2004 SSD COMPANY LIMITED. All Rights Reserved.



**WARRANTY / XaviXPORT****LIMITED WARRANTY**

Subject to the terms and conditions below, SSD COMPANY LIMITED, located at 3-3-4 Higashiyagura, Kusatsu-city, Shiga 525-0054, Japan ("SSD"), warrants to the original purchaser that the XaviXPORT system console and included accessories (collectively, the "Product") shall be free from defects in material and workmanship for one (1) year from the date of purchase (the "Warranty Period"). If a defect covered by this limited warranty occurs during the Warranty Period, SSD will repair or replace, at its option, the defective Product free of charge. However, costs associated with shipping the Product in connection with obtaining warranty service shall be at the purchaser's expense. SSD's repair or replacement shall be purchaser's exclusive remedy with respect to any breach of the limited warranty.

**OBTAINING WARRANTY SERVICE**

To receive instructions for obtaining repair or replacement warranty services, the purchaser must:

- (a) call the SSD Customer Support Hotline at 1-866-XaviXGo; or
- (b) write to the following address: XaviX Product Registration Department, P.O. Box 26490 San Diego, CA 92196-0490, U.S.A.; or
- (c) send an e-mail to [service@xavix.com](mailto:service@xavix.com).

To receive warranty services, the purchaser must also provide a proof of purchase (in the form of a dated bill of sale or invoice receipt) evidencing that the request for service was made within the Warranty Period.

**EXCLUSIONS FROM THE LIMITED WARRANTY**

This limited warranty shall not apply if the Product: (a) is used with products not sold or licensed by SSD (including, but not limited to, any non-licensed software enhancement, copier device, controller, adapter, or power supply) or otherwise with products that are not compatible with the Product; (b) is used for any commercial purpose (including rental or leasing); (c) is modified or tampered with; (d) is damaged by any Act of God, misuse, abuse, negligence, accident, wear and tear, unreasonable use, or by other causes unrelated to defective materials or workmanship; or (e) has had the serial number altered, defaced or removed. This limited warranty does not cover consumables (such as batteries).

**NO OTHER WARRANTIES, LIMITATION OF LIABILITY**

TO THE EXTENT PERMITTED BY APPLICATION LAW, THIS LIMITED WARRANTY IS IN LIEU OF ALL OTHER WARRANTIES, WHETHER ORAL OR WRITTEN, EXPRESS OR IMPLIED, INCLUDING ANY WARRANTY OF MERCHANTABILITY OR FITNESS FOR A PARTICULAR PURPOSE, AND NO OTHER REPRESENTATION OF ANY NATURE SHALL BE BINDING ON OR OBLIGATE SSD. IF ANY SUCH WARRANTY IS INCAPABLE OF EXCLUSION, INCLUDING IMPLIED WARRANTIES OF MERCHANTABILITY AND FITNESS FOR A PARTICULAR PURPOSE, SUCH WARRANTY IS HEREBY LIMITED IN DURATION TO THE WARRANTY PERIOD DESCRIBED ABOVE (1 YEAR OR 90 DAYS AS APPLICABLE). IN NO EVENT SHALL SSD BE LIABLE FOR ANY CONSEQUENTIAL, INCIDENTAL, INDIRECT OR SPECIAL DAMAGES RELATING IN ANY WAY TO THE PRODUCT OR THIS WARRANTY.

Some states do not allow limitations on how long an implied warranty lasts or exclusion of certain damages, so the above limitations may not apply to the purchaser. This limited warranty gives the purchaser specific legal rights, and the purchaser may also have other rights which vary from state to state or province to province. If any term of this limited warranty is prohibited by applicable law, it shall be null and void and the remainder of this limited warranty shall remain in full force and effect.

This limited warranty is valid only in North America.