

The Samsung logo, consisting of the word "SAMSUNG" in white capital letters inside a blue oval.

DVD PLAYER

DVD/ VIDEO-CD/ CD

DVD-N2000

The Samsung logo, consisting of the word "SAMSUNG" in white capital letters inside a blue oval.

ELECTRONICS

SAMSUNG ELECTRONICS AMERICA INC.
105 CHALLENGER ROAD, RIDGEFIELD
PARK, NJ 07660 U.S.A.



FOR YOUR NEAREST SAMSUNG
SERVICE CENTER
DIAL 1-800-SAMSUNG

AH68-00433A

Precautions

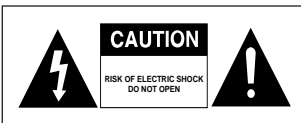

TO REDUCE THE RISK OF ELECTRIC SHOCK, DO NOT REMOVE THE COVER(OR BACK). NO USER-SERVICEABLE PARTS ARE INSIDE. REFER SERVICING TO QUALIFIED SERVICE PERSONNEL.



This symbol indicates “dangerous voltage” inside the product that presents a risk of electric shock or personal injury.



This symbol indicates important instructions accompanying the product.

CAUTION: DVD PLAYERS USE AN INVISIBLE LASER BEAM WHICH CAN CAUSE HAZARDOUS RADIATION EXPOSURE IF DIRECTED. BE SURE TO OPERATE PLAYER CORRECTLY AS INSTRUCTED.

CAUTIONS

Caution: To prevent electric shock, match wide blade of plug to wide slot, fully insert.

Attention: Pour éviter les chocs électriques, introduire la lame la plus large de la fiche dans la borne correspondante de la prise et pousser jusqu'au fond.

This product satisfies FCC regulations when shielded cables and connectors are used to connect the unit to other equipment. To prevent electromagnetic interference with electric appliances, such as radios and televisions, use shielded cables and connectors for connections.

FCC NOTE (for U.S.A):

This equipment has been tested and found to comply with the limits for a Class B digital device, pursuant to Part 15 of the FCC rules. These limits are designed to provide reasonable protection against harmful interference in a residential installation. This equipment generates, uses and can radiate radio frequency energy and, if not installed and used in accordance with the instructions, may cause harmful interference to radio or television reception, which can be determined by turning the equipment off and on, the user is encouraged to try to correct the interference by one or more of the following measures.

- Reorient or relocate the receiving antenna.
- Increase the separation between the equipment and receiver.
- Connect this equipment into an outlet on a circuit different from that to which the receiver is connected.
- Consult the dealer or an experienced radio/TV technician for help.

This class B digital apparatus meets all requirements of the Canadian Interference -- Causing Equipment Regulations.

CLASS 1 LASER PRODUCT
LUOKAN 1 LASER LAITE
KLASS 1 LASER APPARAT

WARNING

To reduce the risk of fire or shock hazard, do not expose this DVD player to rain or moisture.

CAUTION

THIS PRODUCT UTILIZES A LASER. USE OF CONTROLS OR ADJUSTMENTS OR PERFORMANCE OF PROCEDURES OTHER THAN THOSE SPECIFIED HEREIN MAY RESULT IN HAZARDOUS RADIATION EXPOSURE. DO NOT OPEN COVER AND DO NOT REPAIR YOURSELF. REFER SERVICING TO QUALIFIED PERSONNEL.

Note:

- This unit can be used only where the power supply is AC 120V, 60Hz. It cannot be used elsewhere.
- This DVD player is designed and manufactured to respond to the Region Management Information. If the Region number of a DVD disc does not correspond to the Region number of this DVD player, the DVD player cannot play the disc.
- This device is protected by U.S. patent numbers 4,631,603, 4,577,216 and 4,819,098 and other intellectual property rights. The use of Macrovision's copy protection technology in the device must be authorized by Macrovision and is intended for home and other limited pay-per-view uses only, unless otherwise authorized in writing by Macrovision. Reverse engineering or disassembly is prohibited.

Handling Cautions

- Before connecting other components to this player, be sure to turn them all off.
- Do not move the player while a disc is being played, or the disc may be scratched or broken, and the player's internal parts may be damaged.
- Do not put a flower vase filled with water or any small metal objects on the player.
- Be careful not to put your hand into the disc tray.
- Do not place anything other than the disc in the disc tray.
- Exterior interference such as lightning and static electricity can affect normal operation of this player. If this occurs, turn the player off and on again with the POWER button, or disconnect and then reconnect the AC power cord to the AC power outlet. The player will operate normally.
- Be sure to remove the disc and turn off the player after use.
- Disconnect the AC power cord from the AC outlet when you don't intend to use the player for long periods of time.
- Clean the disc by wiping in a straight line from the inside to the outside of the disc.

Disc Storage

Be careful not to harm the disc because the data on these discs is highly vulnerable to the environment.

- Do not keep under direct sunlight.
- Keep in a cool ventilated area.
- Store vertically.
- Keep in a clean protection jacket.

Maintenance of Cabinet

For safety reasons, be sure to disconnect the AC power cord from the AC outlet.

- Do not use benzene, thinner, or other solvents for cleaning.
- Wipe the cabinet with a soft cloth.

About Discs

Discs you can play



Digital video discs

5" and 3 1/2", single or double sided, single or dual layer. DVDs are high density optical discs on which high quality picture and audio are recorded by means of digital signals.



Video CDs

5" and 3 1/2" (with or without playback control).



Audio CDs

5" and 3 1/2"



NUON interactive DVD software

Disc Functions

Functions and information available on the DVDs (titles, chapters, subtitles, ratings, multi angles and more) may differ from disc to disc.

- When  appears on screen, it indicates an invalid button press.

Discs that cannot be played

CD-I, CD-ROM, DVD-ROM, DVD-RAM discs cannot be played in this unit.
CD-G can play audio only, not graphics.



Region code

Your DVD player is designed and manufactured to respond to the region management information that is recorded on a DVD disc.

COPY PROTECTION

- Many DVD discs are encoded with copy protection. Because of this, you should only connect your DVD player directly to your TV, not to a VCR. Connecting to a VCR results in a distorted picture from copy-protected DVD discs.
- This product incorporates copyright protection technology that is protected by methods claims of certain U.S. patents and other intellectual property rights owned by the Macrovision Corporation and other rights owners. Use of this copyright protection technology must be authorized by the Macrovision Corporation, and is intended for home and other limited viewing uses only unless otherwise authorized by Macrovision Corporation. Reverse engineering or disassembly is prohibited.

DVD-N2000



TABLE OF CONTENTS

Before You Start	6	Tour of the Remote Control	10
Description	7	• DVD Function Buttons	11
• Front Panel	7	• TV Function Buttons	11
• Front Panel Display	8	• Samsung N2000 Joystick	12
• Rear Panel	9		

SETUP

Choosing a Connection	13	• Connection to a TV	14
• Connection to an Audio System	13		

CONNECTIONS

Using the Setup Menu	15	MediaMacro™ Zoom & Pan	22
Setting Up the Language Features	16	ActionCapture™ Strobe & Snapshot™ Mode	23
Playing a Disc	17	AngleView™ Display & Screen Fit	24
Search & Skip	19	Selecting the Audio Language	25
A-B Repeat & 3D Sound	20	Selecting the Subtitle Language	26
Bookmark	21		

PLAYBACK

Spectrum Analyzer & Game	27	Setting Up the Parental Control	30
Using the Display Function	28	Setting Up the Audio Options	31
Setting Up the Disc Language	29	Setting Up the Display Options	32

SPECIALS

Remote Control Setting	33	Specifications	35
Troubleshooting Guide	34	Warranty	36

REFERENCE

Accessories

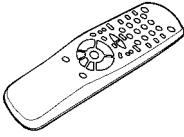

Remote Control

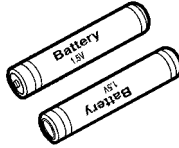

Batteries for Remote Control (AA Size)

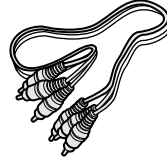

Video/Audio Cable

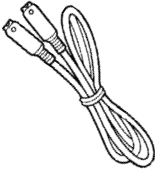

S-Video Cable



User's Manual



Joy Stick

Install Batteries in the Remote

- 1 Open the battery cover on the back of the remote.
- 2 Insert two AA batteries. Make sure that the polarities (+ and -) are aligned correctly.
- 3 Replace the battery cover.

If remote doesn't operate properly:

- Check the polarity + - of the batteries (Dry-Cell)
- Check if the batteries are drained.
- Check if remote sensor is blocked by obstacles.
- Check if there is any fluorescent lighting nearby.

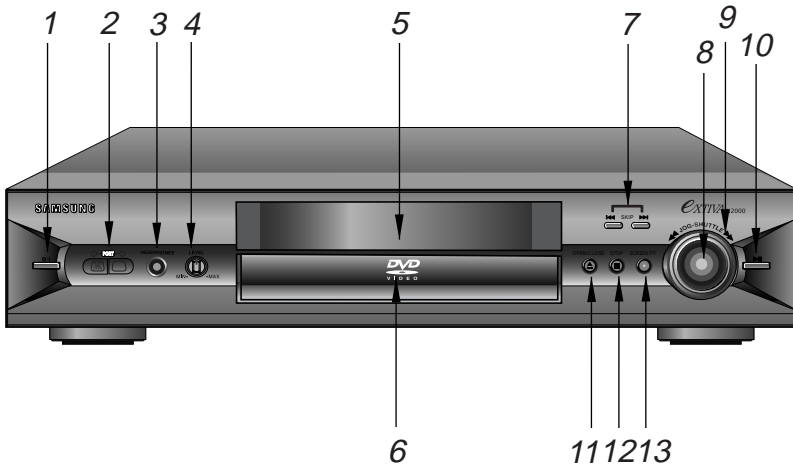

Front Panel Controls

1 STANDBY/ON

- When the unit is first plugged in, this indicator lights.

2 NUON PORTS

- Allow you to plug in joystick or other peripherals.

3 HEADPHONES JACK

- You can attach headphones here for private listening.

4 HEADPHONES VOLUME

- Use to adjust headphones volume level.

5 DISPLAY

- Operation indicators are displayed here.

6 DISC TRAY

- Press OPEN/CLOSE to open and close the disc tray.

7 SKIP

- Use to skip chapters or tracks.

8 JOG DIAL

- Operates frame by frame playback.

9 SHUTTLE DIAL

- Performs fast or slow motion playback.

10 PLAY/PAUSE

- Begin or pause disc play.

11 OPEN/CLOSE

- Press to open and close the disc tray.

12 STOP

- Stops disc play.

13 SCREEN FIT

- Allows you to eliminate the black bars of the screen and fill any TV screen completely with the picture.

Front Panel Display

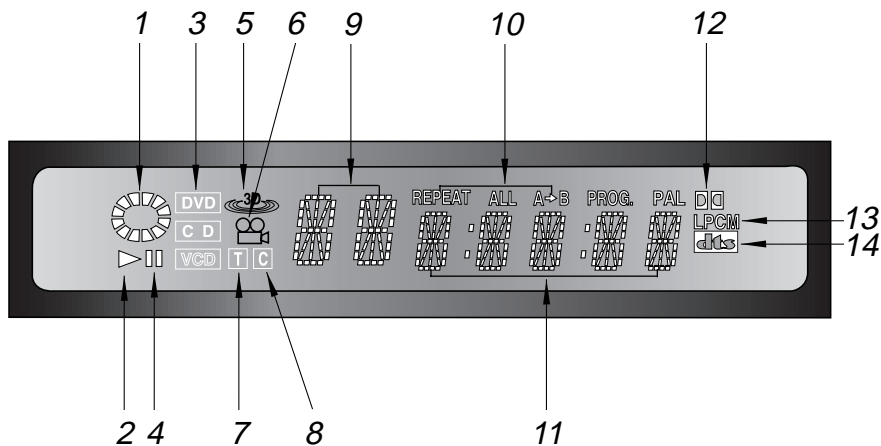

Front Panel Indicators

- 1 Indicates Disc is turning
- 2 Disc playback
- 3 Disc type indicators
- 4 Still picture or audio pause
- 5 Lights when 3D surround is turned on.
- 6 Angle indicator. You can select multiple angles of a scene recorded by different cameras.
- 7 DVD : Title number, Video/Audio CD : Track number
- 8 DVD : Chapter number.
- 9 Displays title, chapter or track number.
- 10 Repeat play mode
- 11 Displays various messages concerning operations such as PLAY, STOP, LOAD, ...
 - no DISC** : No disc loaded.
 - OPEN** : The disc tray is open.
 - LOAD** : Player is loading disc information.
 - HDCD** : When an HDCD[®] recording is detected, the letters "HDCD" will flash for about 10 seconds at the beginning of the track. (See NOTE below.)
- 12 Dolby Digital Disc
- 13 Linear PCM audio output
- 14 DTS (Digital Theater System) output

NOTE

HDCD

This product is equipped with HDCD[®] decoding and filtering technology. Please note that HDCD playback decoding will increase the dynamic range of CDs recorded with the HDCD process, which may cause their average level to sound quieter than other CDs.

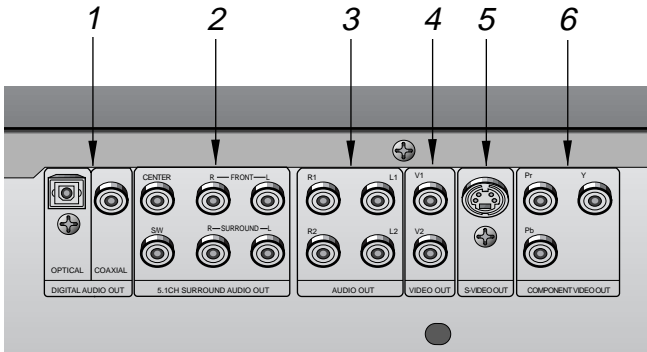

Rear Panel Jacks

1 DIGITAL AUDIO OUT JACK

- Use either an optical or coaxial digital cable to connect to a compatible Dolby Digital receiver. Use to connect to an A/V Amplifier that contains a Dolby Digital decoder or DTS decoder.

2 5.1CH SURROUND AUDIO OUT JACKS

- Connect to an amplifier with 5.1CH analog input jacks.

3 AUDIO OUT JACKS

- Connect to the Audio input jacks of your television, audio/video receiver, or VCR.
- Audio will be output via Front (R/L) of the analog audio out jacks except for CASE1 (2CH).

4 VIDEO OUT JACKS

- Use a video cable to connect one of these jacks to the Video input on your television.

5 S-VIDEO OUT JACK

- Use the S-Video cable to connect this jack to the S-Video jack on your television for a higher quality picture.

6 COMPONENT VIDEO OUT JACKS

- Use these jacks if you have a TV with Component Video in jack on your television for a higher quality picture.

To Connect Headphones (not included)



Connect headphones with a standard stereo plug to the headphone jack (M6).

- Before connecting, set headphone volume at minimum. Then adjust to a suitable volume.

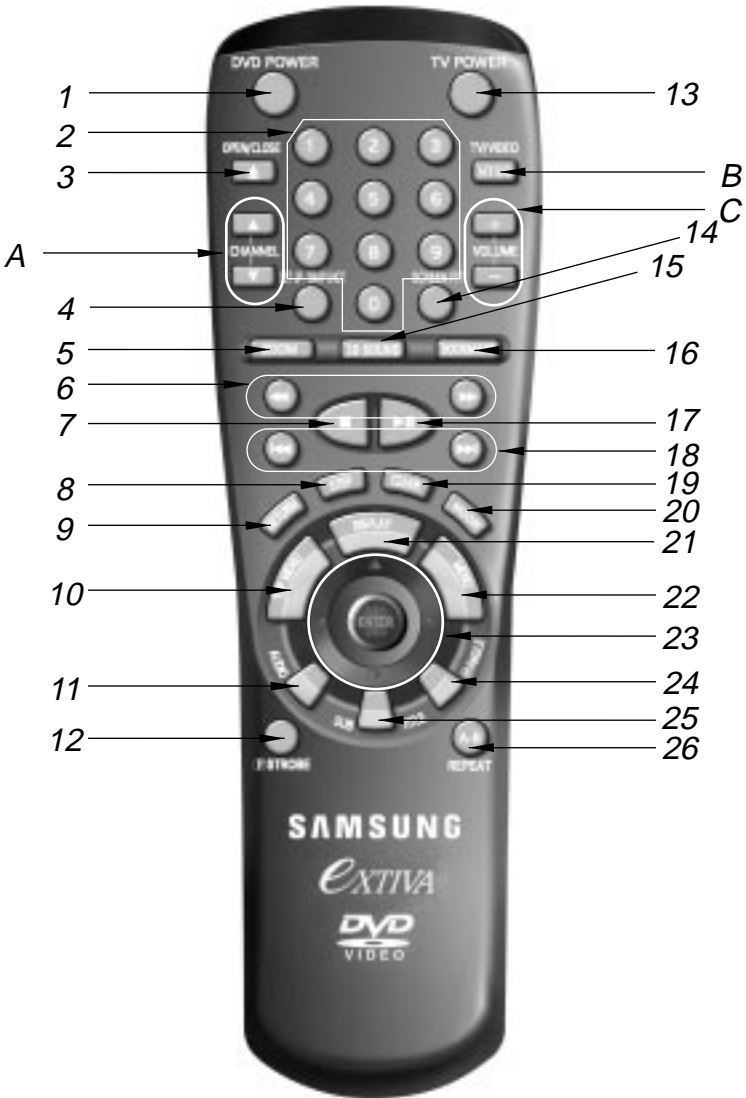
Tour of the Remote Control



DVD Function Buttons

- 1 DVD POWER**
- 2 NUMBER**
- 3 OPEN/CLOSE**
- 4 SETUP/SNAP SHOT**
 - During normal play, pressing the SETUP button will bring up the DVD player's Setup menu. When the SETUP button is pressed in the "pause" mode (when the PAUSE button has been pressed), a special image processing menu comes up on the screen. This menu allows you to modify the picture characteristics- Gamma, color, contrast, and brightness- of the still image on the screen.
- 5 ZOOM**
- 6 SEARCH**
 - Allows you to search forward/backward through a disc while it is in play mode (or slow speed search in pause mode).
- 7 STOP**
- 8 STEP**
 - Advances playback one frame at a time.
- 9 RETURN**
 - Returns to previous state.
- 10 TOP MENU**
 - Takes you to the menu on the DVD disc or CD/VCD.
- 11 AUDIO**
 - Use this button to access various audio functions on a disc.
- 12  STROBE**
 - Pressing this button divides the screen into 9 blocks. A continuous motion snap-shot advancing every 0.5 seconds is split across these blocks in order.
- 13 TV POWER**
 - Use to set the remote to control a compatible TV.
- 14 SCREEN FIT**
 - Allows you to eliminate the black bars at the top and bottom of the screen.
- 15 3D SOUND**
 - Use to simulate the surround effect through speaker or headphones.
- 16 BOOKMARK**
 - Use to memorize scenes for replay.
- 17 PLAY/PAUSE**
 - Begin/Pause disc play.
- 18 SKIP**
 - Use to skip the title, chapter, or track.
- 19 CLEAR**
 - Use to remove menus or status displays from the screen.
- 20 NUON**
 - Pressing this button brings up a special NUON menu. When a DVD disc has enhanced NUON content, you can navigate and view this extra content by going to this menu first.
- 21 DISPLAY**
 - Brings up a "SmartMarrix™ user interface" On-screen display, that displays the current disc mode (for DVD) and allows you instant access to the DVD features. During CD playback this brings up a VLM (Virtual Light Machine™) screen.
- 22 MENU**
 - Brings up the Disc menu.
 - Use to select the various VLM screens.
- 23 ENTER/DIRECTION (UP/DOWN or LEFT/RIGHT)**
 - This button functions as a toggle switch.
- 24  ANGLE**
 - Use to access multiple angles on a DVD.
- 25 SUBTITLE**
- 26 A-B REPEAT**
 - Use to mark a segment to repeat between A and B.

TV Function Buttons

- | | |
|------------------------------------|---------------------------------|
| A CHANNEL UP/DOWN Buttons | C VOLUME UP/DOWN Buttons |
| B TV/VIDEO Selection Button | |

Samsung N2000 Joystick

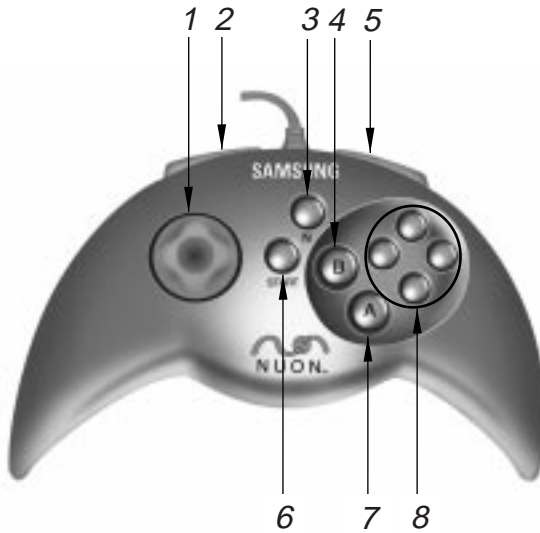

Joystick Controls

- 1 D (Up/ Down/ Left/ Right) Button
- 2 Front Left Button
- 3 NUON Button
- 4 B Button
- 5 Front Right Button
- 6 Start Button
- 7 A Button
- 8 C (Up/ Down/ Left/ Right) Buttons

Choosing a Connection

The following show examples of connections commonly used to connect the DVD player with a TV and other components.

Before Connecting the DVD Player

- Always turn off the DVD player, TV, and other components before you connect or disconnect any cables.
- Refer to user's manual of the components you are connecting for more information on those particular components.

Connection to an Audio System

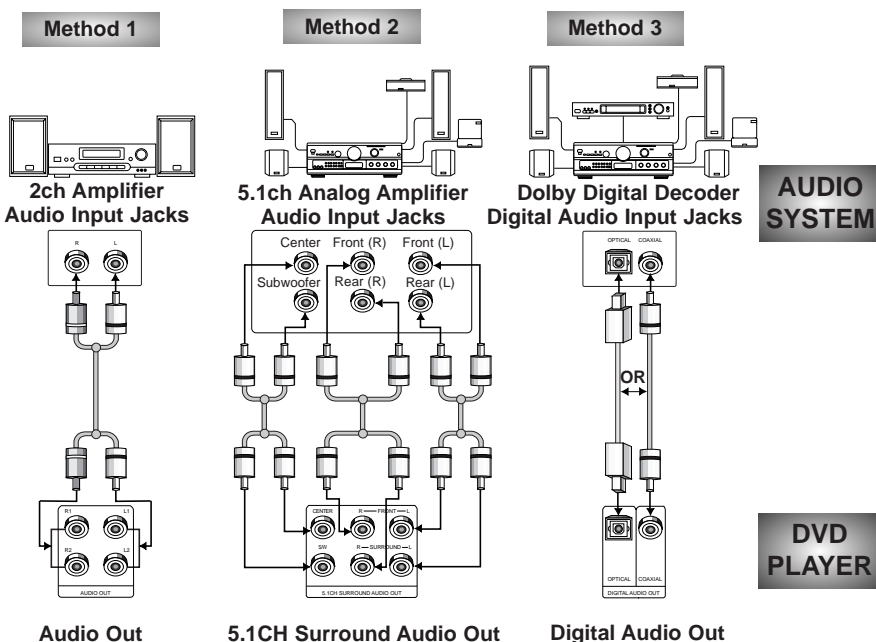

Connection to an Audio System

- **Method 1** DVD Player + 2CH Stereo Amplifier, Dolby Pro Logic Decoder (Speaker setup menu should be set to Case 1 (See page 31).)
- **Method 2** DVD Player + Amplifier with 5.1CH Surround Audio Input Jacks
- **Method 3** DVD Player + Amplifier with Dolby Digital Decoder/DTS Decoder

CONNECTIONS

Choosing a Connection

Connection to a TV

TV (Normal, Widescreen, Projection, etc..)

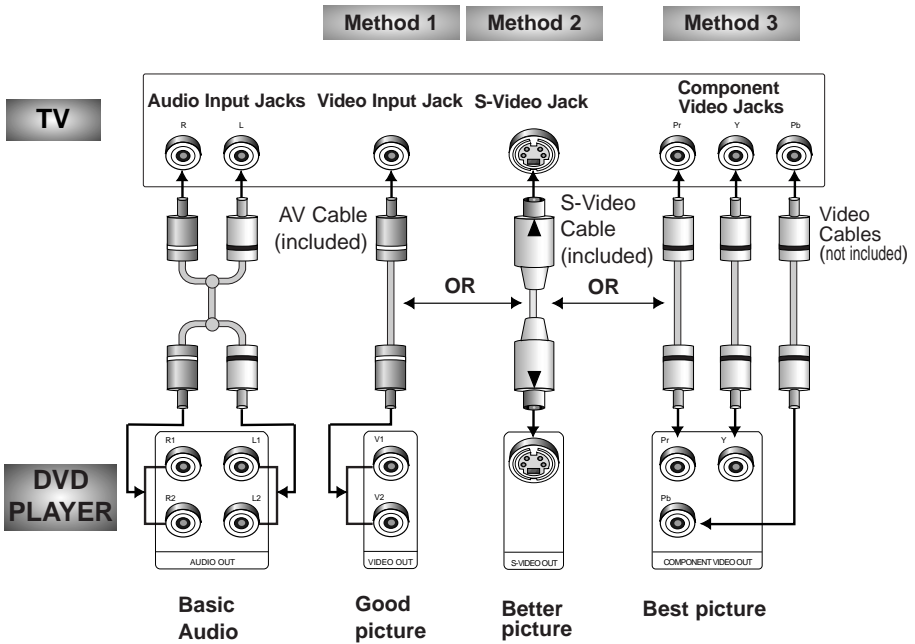

Connection to a TV (For Video)

- **Method 1** DVD Player + TV with Video Input Jack
- **Method 2** DVD Player + TV with S-Video Input Jack
- **Method 3** DVD Player + TV with Component Video Jacks

The Setup Menu lets you customize your DVD player by allowing you to select various language preferences, set up a parental control, even adjust the player to the type of television screen you have.

1 Press the SETUP button on the remote.

DISC MENU

Setup of the Menu Language (See page 29)

Use the Menu preference menu to select the language you want a DVD's disc menu to be displayed in.

AUDIO

Setup of the Audio Language (See page 16)

Use the Audio preference menu to select the soundtrack language.

SUBTITLE

Setup of the Subtitle Language (See page 16)

Use the Subtitle preference menu to select the language the disc's subtitles are to be displayed in.

PARENTAL

Setup of the Parental Control (See page 30)

Use to deny playback of discs or scenes with objectionable material.
(Must be supported by the disc.)

AUDIO OPTIONS

Setup of the Audio Options (See page 31)

Use to set up the audio options such as speaker setup.

DISPLAY OPTIONS

Setup of the Display Options (See page 32)

Use to select which type of screen you want to watch and several display options.

2 Use the UP/DOWN button on the remote to access the different features.

3 Press the ENTER button to access the sub features.

To make the setup screen disappear after setting up, press the SETUP button again.

NOTE

- Not all Setup Menu selections will work - this is dependent on the DVD disc content. For example, the subtitle setup menu option will not have any effect on a disc that does not have subtitle support. The Setup menu won't work with VCDs.
- Changes made to the first three Setup Menu items (1. Disk Menu, 2. Audio, 3. Subtitle) will only become effective after opening and closing the disc tray.

Setting Up the Language Features

Using the Audio Language



ex) Setting up in ENGLISH.

- 1 Press the SETUP button.
- 2 Press the UP/DOWN button to move to AUDIO.
- 3 Press the ENTER button.
- 4 Use the UP/DOWN button to select 'ENGLISH' .
- Select "ORIGINAL" if you want the default soundtrack language to be the original language the disc is recorded in.
- 5 Press the ENTER button.
- ENGLISH is selected and the screen returns to SETUP MENU.

Using the Subtitle Language

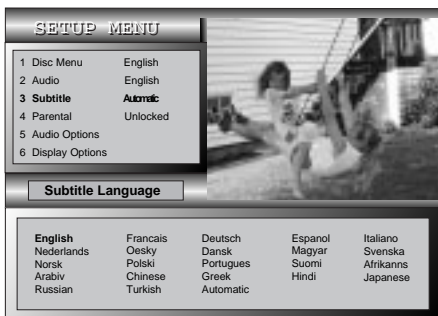

ex) Setting up in ENGLISH.

- 1 Press the SETUP button.
- 2 Use the UP/DOWN button to select SUBTITLE.
- 3 Press the ENTER button.
- 4 Use the UP/DOWN button to select 'ENGLISH' .
- Select "AUTOMATIC" if you want the subtitle language to be the same as the language selected as the audio preference.
- 5 Press the ENTER button.
- ENGLISH is selected and the screen returns to SETUP MENU.

NOTE

- If the selected language is not recorded on the disc, the original pre-recorded language is selected.
- **How to make the SETUP MENU disappear or return to menu screen during set up;** Press the RETURN button.

Playback

- 1** Press the OPEN/CLOSE button.
The STANDBY indicator light goes out and the tray opens.
- 2** Place a disc gently into the tray with the disc's label facing up.
- 3** Press the PLAY/PAUSE button to start playback.
- 4** Press the STOP button to stop playback.

RESUME function

When you stop disc play, the player remembers where you stopped, so when you press PLAY again, it will pick up where you left off (unless the disc is removed, the STOP button is pressed twice or the player is unplugged.).

NOTE

- If the player is left for 5 minutes in pause mode, it will stop.
- The power is automatically turned off after approximately 30 minutes have elapsed in the stop mode (auto power-off feature).
- If the player is left in stop mode for more than one minute without any user interaction, a screen saver will be activated.
- This  icon indicates an invalid button press.

Playing a Disc

1 Stop

Press the STOP button during playback.

2 Remove

Press the OPEN/CLOSE button.

3 Pause

Press the PLAY/PAUSE or STEP button on the remote during playback.

- Screen stops, no sound.
- To resume, press the PLAY/PAUSE button once again.

4 Step Motion (Except CD)

Press the STEP button on the remote during playback.

- Each time the button is pressed, a new frame will appear.
- No sound is heard during STEP mode.
- Press PLAY/PAUSE to resume normal playback.
(You can only perform step motion playback in the forward direction.)

5 Slow Motion (Except CD)

Press the FWD or REV SEARCH button on the remote during PAUSE or STEP mode.

- By pressing or shuttling, you can select slow motion playback for 1/2, 1/4 or 1/8 of normal speed.
- No sound is heard during slow mode.
- Press PLAY/PAUSE to resume normal playback.
- When playing a VCD, reverse slow motion playback will not work.

Searching a Chapter/Track

Searching is not restricted to within a "chapter" or "track".

Press the FWD or REV SEARCH button on the remote or turn the SHUTTLE dial on the front of the DVD player during play back.

- Press the REVERSE or FORWARD SEARCH button on the remote and press again to search at a faster speed(2X/4X/8X/16X/32X/normal speed, in order) on the DVD.
- Press the REVERSE or FORWARD SEARCH button on the remote and press again to search at a faster speed(2X/4X/8X/normal speed in order) on VCD and CD.
- To return to normal speed playback, press the PLAY/ PAUSE button.

Skipping Tracks

The skip function allows you to "skip" from one chapter another in the forward or reverse direction.

Press the NEXT SKIP or BACK SKIP button during playback.

- When playing a DVD, if you press the NEXT SKIP button, it moves to the next chapter. If you press the BACK SKIP button, it moves to the beginning of the chapter. One more press makes it move to the beginning of the previous chapter.
- When playing a VCD or a CD, if you press the NEXT SKIP button, it moves to the next track. If you press the BACK SKIP button, it moves to the the beginning of the track. One more press makes it move to the beginning of the previous track.

NOTE

- When in search mode (4X/8X/16X/32X) on a DVD or high-speed playback on a VCD, no sound will be heard.
- Depending on the disc, audio may not be heard when a disc is in 2X playback mode.

A-B Repeat & 3D Sound

A-B Repeat

The A-B Repeat function lets you mark a segment to repeat between the beginning (A) and the end (B) of the segment you want to review.

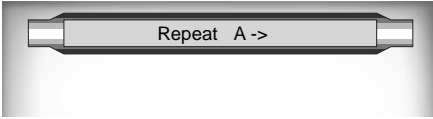

- 1 Press the A-B REPEAT button at the beginning (A) of the segment you want to review.

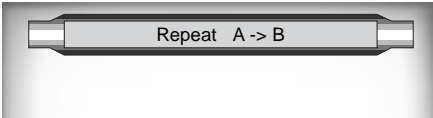

- 2 Press the A-B REPEAT button again at the end (B) of the segment you want to review. The segment will begin repeating.

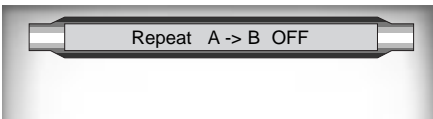

- 3 To clear A-B Repeat, press the A-B REPEAT button again.

3D Sound

The simulated surround effect (SPATIALIZER N-2-2) depends on the disc contents. If you connect the unit to your stereo system, you can enhance sound quality and produce a greater surround effect. This feature is useful when you are using the DVD player with a two channel stereo through the analog outputs.

(Discs which are recorded with DTS will not work. When the DIGITAL OUTPUT is set to BITSTREAM in the SETUP MENU, the 3D Sound function will not work.)

- 1 Press the DISPLAY button. Use the UP/DOWN or LEFT/RIGHT to select 3D Sound. Or press the 3D SOUND button on the remote. (Be sure the DIGITAL OUTPUT is set to PCM.)
- 2 Use the UP/DOWN button to select the sound you want among Speakers, Headphones or Off.(on DVD/VCD)
(When playing a CD, you can select On or Off.)

NOTE

- The A-B Repeat function works on the same title or track.
- If the title or track is completed before marking the end (B), the end of the title or track becomes B automatically.
- Depending on the disc, the A-B Repeat and 3D Sound functions may not work.
- 3D sound will not operate in VLM (Virtual Light Machine) mode.

The Bookmark function lets you select parts of a DVD or VCD so that you can quickly find the section at a later time.



During playback, press the BOOKMARK button on the remote. A 'BOOKMARK' will be displayed.

To store a Bookmark

- 1 Use the LEFT/RIGHT button to move to the desired bookmark.
- 2 When you reach the scene you want to mark, press the ENTER button. The icon will change to a number (1, 2, or 3).
- 3 Press the BOOKMARK button to turn off the display.

To recall a Bookmarked scene

- 1 During playback, press the BOOKMARK button on the remote.
- 2 Use the LEFT/RIGHT button to select a marked scene.
- 3 Press the PLAY/PAUSE button to skip to the marked scene.

To clear a Bookmark

- 1 During playback, press the BOOKMARK button on the remote.
- 2 Use the LEFT/RIGHT button to select the bookmark number you want to delete.
- 3 Press the CLEAR button to delete a bookmark number. Press the BOOKMARK button to turn off display.

NOTE

- Up to three scenes may be marked at the same time.
- Depending on the disc, the Bookmark function may not work.

MediaMacro™ Zoom & Pan

MediaMacro™ Zoom & Pan

For DVDs, VCDs

This function allows complete control over what part of the picture you want to see. You can select any portion of the screen and magnify that portion up to 20 times.



- 1 Pressing the ZOOM button one time, brings up a square frame (Zoom 1 state as shown in the figure above left).
- 2 Pressing the UP button while in the Zoom 1 state, enables you to zoom in, and pressing the DOWN button while in the Zoom 1 state enables you to zoom out.
- 3 Pressing the ZOOM button while in the Zoom 1 state, brings up the square frame with a "cross" (Zoom 2 state as shown in the figure above right).
- 4 Pressing the UP/DOWN button while in the Zoom 2 state, allows you to traverse the Zoomed picture vertically (screen position reflected by the horizontal line of the "cross").
- 5 Pressing the LEFT/RIGHT button while in the Zoom 2 state allows you to traverse the Zoomed picture horizontally (screen position reflected by the vertical line of the "cross").
- 6 Pressing the ZOOM button one more time (in the Zoom 2 state), clears the Zoom function.

NOTE

- Depending on the disc, the MediaMacro™ Zoom & Pan function may not work.

ActionCapture™ Strobe & SnapShot™ Mode

ActionCapture™ Strobe

This unique strobe function takes snapshots of a continuous motion, then displays these snapshots in order. This is a useful method of analyzing golf swings, a pianist's finger movements or even a pitcher's technique.

The screen is divided into fixed 9 subscreens. Press the **Ⓢ** STROBE button.



To clear the ActionCapture™ Strobe, press **Ⓢ** STROBE again.

SnapShot™ Mode

When the SETUP button is pressed in the "pause" mode (when the PAUSE button has been pressed), a special image processing menu comes up on the screen. This menu allows you to modify the picture characteristics - Gamma, color, contrast, and brightness - of the still image on the screen.

- 1 Use the UP/DOWN button to navigate amongst the four image processing options.
- 2 Use the LEFT/RIGHT button to modify the setting for each option.
- 3 To clear SnapShot™ mode, press the SETUP button again.

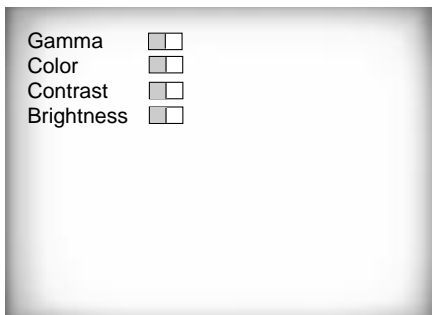



- Pressing the SETUP button during normal mode will bring up the setup menu display.

AngleView™ Display & Screen Fit

Using the Ⓜ ANGLE button

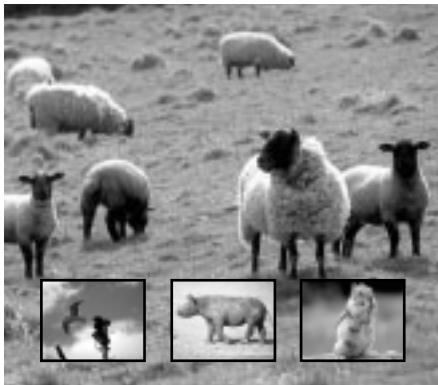
The DVD-N2000 displays each angle in a portion of the screen, allowing you to select any angle at the touch of the ergonomic remote.



Check to see if an 'ANGLE' () mark is present at the upper right hand corner of the screen.

- 1 When an 'ANGLE' mark is shown, press the ⓂANGLE button.
- 2 Use the LEFT/RIGHT button to select the desired screen angle. Then press the ENTER button.

Example) If there are 3 angles available

Screen Fit

Press the SCREEN FIT button on the remote or the front panel.

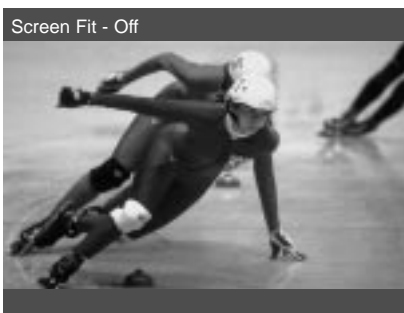

- Allows you to eliminate the black bars at the top and bottom of the screen when playing a widescreen(16:9) ratio movie.
- Pressing the SCREEN FIT button when the zoom mode is active will not have any effect (the black bars, when viewing in letter-box mode, will remain). However, pressing the ZOOM button when the Screen fit function is active already will enable the Zoom mode.

NOTE

- Depending on the disc, the ActionCapture™ Strobe and Screen Fit functions may not work.
- This function does not work when a DVD has not been recorded with a multi-camera angle system.

Selecting the Audio Language

You can select a desired language quickly and easily with the AUDIO button.

Using the AUDIO Button

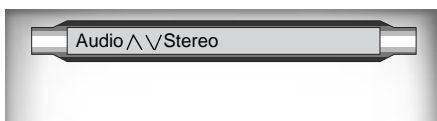
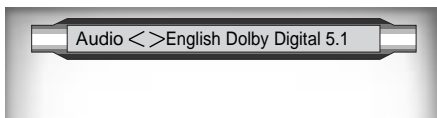

- 1 Press the AUDIO button.
- 2 Use the LEFT/RIGHT button to select the desired language on a DVD.
- The audio and subtitle languages are represented by abbreviations.
- 3 Use the UP/DOWN button to select Stereo, Right Channel or Left Channel. (On VCD/CD)

Using the MENU Button

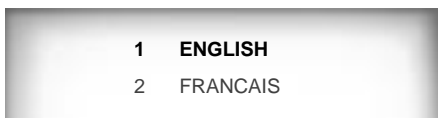
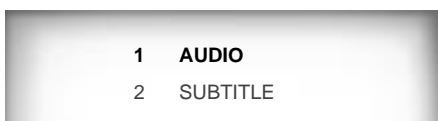

(example)

When playing a DVD

- 1 Press the MENU button.
- 2 Use the UP/DOWN button to select AUDIO information.
- 3 Press the ENTER button.
- 4 Use the UP/DOWN button to select 'ENGLISH'.
- 5 Press the ENTER button.

When playing a VCD/CD

When playing a VCD or CD, the MENU button will not work.

NOTE

- This function depends on what languages are encoded on the disc and may not work with all DVDs.
- A DVD disc can contain up to 8 audio languages.
- **How to have the same audio language come up whenever you play back a DVD;** Refer to "Setting Up the Language Features" on page 16.

Selecting the Subtitle Language

You can select a desired subtitle quickly and easily with the SUBTITLE button.

Using the SUBTITLE Button



1 Press the SUBTITLE button.

2 Use the LEFT/RIGHT button to select the desired subtitle language.

3 Use the UP/DOWN button to determine whether or not the subtitle will be displayed.

- Initially, the subtitling will not appear on screen.

- The audio and subtitle languages are represented by abbreviations.

Using the MENU Button

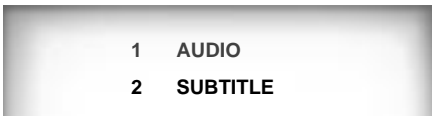

(example)

1 Press the MENU button.

2 Use the UP/DOWN button to select SUBTITLE information.

3 Press the ENTER button.

4 Use the UP/DOWN button to select the desired language.

5 Press the ENTER button.

When playing a VCD/CD

When playing a VCD or CD, the MENU button will not work.

NOTE

- This function depends on what languages are encoded on the disc and may not work with all DVDs.
- A DVD disc can contain up to 32 subtitle languages.
- **How to have the same audio language come up whenever you play back a DVD;** Refer to "Setting Up the Language Features" on page 16.

Spectrum Analyzer

Your Extiva player brings audio CDs to life with the aid of stunning visual effects. The first screen that comes up when playing an audio CD is a Spectrum Analyzer as shown in the figure (above left). This displays a level meter, the track number and elapsed time for the CD being played.

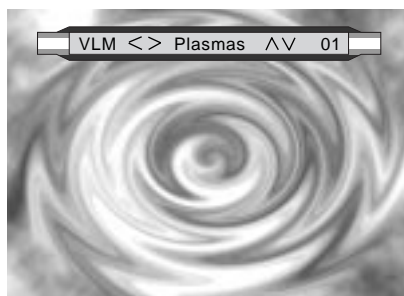
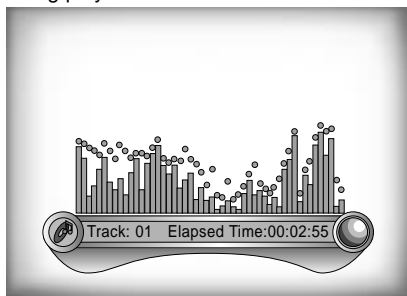

Pressing the DISPLAY button, brings up the VLM (Virtual Light Machine™) screen. There are 12 built-in VLM screens with your Extiva player, and you can select from 10 VLM subscreens by pressing MENU and UP/DOWN or LEFT/RIGHT (as shown in the figure above right).

- VLM is a series of stunning and incredibly fun visual effects that are 'synchronized' to the music being played.
- Two of the VLM screens, Random Time and Random Energy, do not have subscreens.

Gaming

Your Extiva player, in addition to playing DVD movies, VCD and CD-Audio discs, also supports a wide variety of NUON entertainment and edutainment software titles. NUON ports on the front panel allow you to plug in a wide variety of NUON peripherals, including joysticks. There are two NUON ports on the front panel of your Extiva player. To play a NUON game, you need to connect a NUON joystick to either of these ports (or connect multiple NUON joysticks - two supported by the ports on the front panel, multiple joystick support provided via a NUON splitter that connects to these NUON ports) and insert the NUON game disc in the tray. Depending on the game disc, you may not be able to hear audio via the digital audio out jack. If this occurs, you must hook up the analog outputs to hear NUON game disc audio.

- 1 Connect the joystick to one of the ports. Insert the game disc in the tray.
- 2 Press the PLAY/PAUSE button to start playback.

- Samsung N2000 Joystick button Mapping for DVD, VCD, CDDA playback. Button mapping for Nuon depends on the Nuon disc. Nuon button usage is different from disc to disc.
- Unplugging and replugging a joystick when playing a game may cause program dysfunction. If this occurs, press POWER on the front panel to re-initialize the program.

Joystick Buttons	Remote Buttons	Joystick Buttons	Remote Buttons
Start Button	Play/ Pause	C-Left Button	Fast Reverse
A Button	Enter	C-Right Button	Fast Forward
D-Up Button	Up	NUON Button	NUON
D-Down Button	Down	Front Left Button+ N Button	Display
D-Left Button	Left	Front Right Button+ N Button	Setup
D-Right Button	Right	Front Right Button+ N Button	Open Disc Tray
C-Up Button	Skip Next	Front Left Button	(Use Start Button to close tray)
C-Down Button	Skip Previous		

Using the Display Menu

The unique “SmartMatrix™ user interface” on Screen Display of the DVD-N2000 allows instant access to both the DVD features and the more advanced PC-like functions. And the picture is never out of view, as these advanced graphics can be displayed simultaneously with the DVD images.

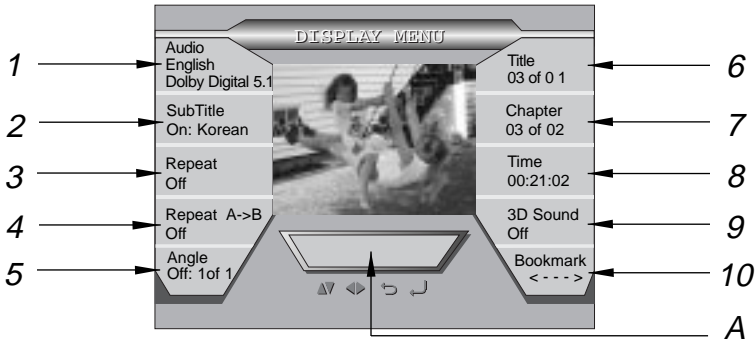

- If Audio, Subtitle and Repeat, etc. are selected, they will be highlighted (when playing a VCD, title/chapter/time/subtitle part is replaced by track/elapsed time/remain track/remain time.)
- When an item is selected and ENTER is pressed, the item will be displayed in A.
- The A box displays the current status of the item chosen.

- 1 During playback, press DISPLAY, the display menu appears.
- 2 Select the desired item by using the UP/DOWN or LEFT/RIGHT button. Then press ENTER.
- 3 In the A box, you can change desired data.
- 4 To make the screen disappear, press DISPLAY again.

1 **Audio** See page 16.

2 **Subtitle** See page 16.

3 **Repeat**

- The Repeat function allows you to repeat a track, title, or all the disc (CD only). Use to select TITLE, CHAPTER (or TRACK) or OFF.

4 **A-B Repeat** See page 20.

5 **Angle** See page 24.

6 **Title**

- Use to select a title number.
- A DVD may contain several different titles. For example, if a disc contains four different movies, each might be considered a title.

7 **Chapter**

- Use to select a chapter number.
- Each Title on a DVD can be divided into chapters (similar to tracks on an audio CD).

8 **Time**

- Use to enter the time from which you want to start.

9 **3D Sound** See page 20.

10 **Bookmark** See page 21.

(The Bookmark function can't be set here but will be displayed in A.)

Setting Up the Disc Language

If you set the disc menu, audio and subtitle language in advance, they will come up automatically every time you watch a movie.

Using the Disc Menu Language



This function changes the language only for the text on the disc menu screens.

- 1 Press the SETUP button.
- 2 Use the UP/DOWN button to select DISC MENU.
- 3 Press the ENTER button.
- 4 Use the UP/DOWN button to select 'ENGLISH' in the sub-menu.
- 5 Press the ENTER button.

ex) Setting up in ENGLISH.

- ENGLISH is selected and the screen returns to SETUP MENU.

NOTE

- For Audio and Subtitle Setup, see page 16.

Setting Up the Parental Control

The Parental Control function works in conjunction with DVDs that have been assigned a rating - which helps you control the types of DVDs that your family watches. There are up to 8 rating levels on a disc.

Setting the Rating Level

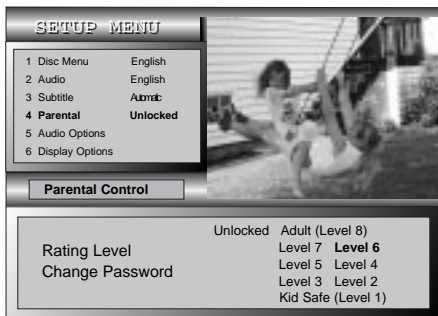

ex) Setting up Level 6.

- 1 Press the SETUP button.
 - 2 Press the UP/DOWN button to select PARENTAL.
 - 3 Press the ENTER button and enter your 4-digit password by pressing the 0-9 button.
 - 4 Move to the RATING LEVEL by using the UP/DOWN button and press the ENTER button.
 - 5 Move to LEVEL 6 by using the UP/DOWN or LEFT/RIGHT button and then press the ENTER button.
- The disc which contains LEVEL 7 or 8 will now not play.

Changing the Password

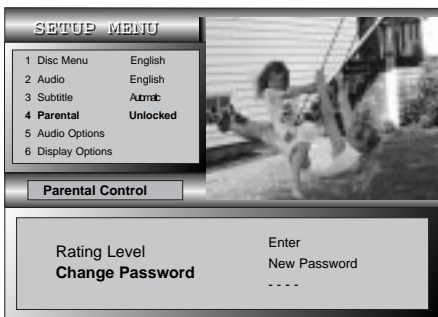

- 1 Press the SETUP button.
 - 2 Press the UP/DOWN button to select PARENTAL.
 - 3 Press the ENTER button and enter your 4-digit password by pressing the 0-9 button.
- The default password is '9999'.
- 4 Move to CHANGE PASSWORD by using the UP/DOWN button and press the ENTER button.
 - 5 Enter the new password.
- After entering the new password, re-enter it one more times to make sure the password works.
 - The Parental Control function is compatible only with parental level encoded discs.

Setting Up the Audio Options

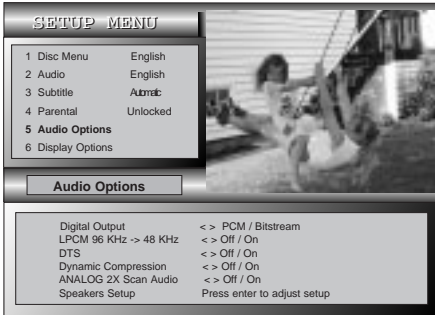

- 1 Press the SETUP button.
- 2 Use the UP/DOWN button to select AUDIO OPTIONS. Then press the ENTER button.
- 3 Use the UP/DOWN button to select the desired item.
- 4 Use the LEFT/RIGHT button to select the desired item. Then press the ENTER button.

DIGITAL OUTPUT

- PCM : Converts to PCM (2CH) 48KHz/16Bit audio. Select PCM when using the Analog Audio Outputs. **If the unit is set to PCM, speaker setup is changed to 2CH and the speaker setup can't be controlled.**
- BITSTREAM : Converts to Dolby Digital BITSTREAM (5.1CH). Select BITSTREAM when using the Digital Audio Output.

LPCM 96 KHz → 48 KHz

- For discs recorded with 96 KHz Linear PCM, you must change 96KHz(Off) to 48KHz(On) for analog and digital output. **PCM won't be output when it is set to LPCM 96 KHz.**

DTS

- ON : Outputs DTS BITSTREAM via digital output only. Select DTS when connecting to a DTS DECODER.
- OFF : Doesn't output DTS signal.

DYNAMIC COMPRESSION

- ON : To select dynamic compression.
- OFF : To select the standard range.

ANALOG 2X SCAN AUDIO

- ON : Turns analog 2X scan audio on. **2X Scan Audio does not work when using the digital output.**
- OFF : Turns analog 2X scan audio off.

SPEAKER SETUP

- CASE 1 -11 : Use the LEFT/RIGHT button to select the desired speaker setup. There are 11 different speaker settings to optimize the DVD player to your audio system.
- Speaker Setup is only available in Bitstream mode.

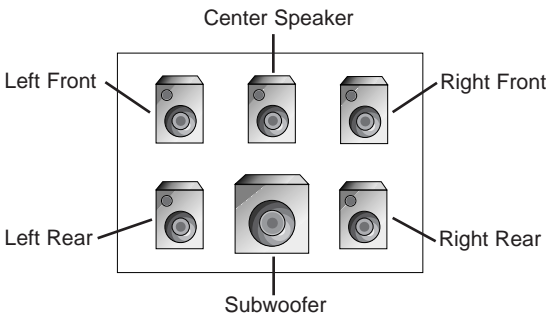

NOTE

- **How to make the SETUP MENU disappear or return to menu screen during set up;** Press RETURN button.
- When the Speaker Setup is set to 5.1CH, the voice recorded on a DVD disc may not be heard if you are connected to a regular 2 channel stereo. If this occurs, the following procedure must be performed: Select PCM in the Digital Output of the Audio Options menu. Or, select CASE1 in the Speaker Setup when the unit is set to BITSTREAM.

Setting Up the Display Options

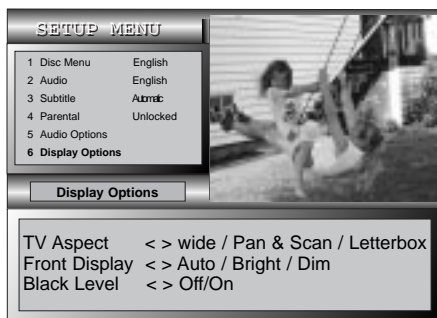

- 1 Press the SETUP button.
- 2 Use the UP/DOWN button to select DISPLAY OPTIONS. Then press the ENTER button.
- 3 Use the UP/DOWN button to select the desired item. Then press the ENTER button.

TV ASPECT

Depending on the type of television you have, you may want to adjust the screen setting (aspect ratio) only in stop mode.

FRONT DISPLAY

Adjust the brightness of the unit's front panel display.

BLACK LEVEL

Adjusts the brightness of the screen.

- 4 Use the LEFT/RIGHT button to select the desired item. Then press the ENTER button.

TV ASPECT

- WIDE :

You can view the full 16:9 picture on your widescreen TV.

- PAN-SCAN :

Select this for conventional size TVs when you want to see the central portion of the 16:9 screen. (Extreme left and right side of movie picture will be cut off.)

- LETTER BOX :

Select when you want to see the total 16:9 ratio screen DVD supplies, even though you have a TV with a 4:3 ratio screen. Black bars will appear at the top and bottom of the screen.

FRONT DISPLAY

- BRIGHT : Makes the Front Panel Display bright.

- DIM : Makes the Front Panel Display dim.

- AUTO DIM : Makes the Front Panel Display dim automatically when playing a DVD.

BLACK LEVEL

- On : Picture will be lighter than the default black level.

- Off : Picture will display as it is set.

Remote Control Setting

The remote can also be set up to control most TVs. To program the remote, use the code that corresponds to your brand.

- 1 Turn on the TV.
- 2 Point the DVD's remote at the TV.
- 3 While holding the TV **POWER** button down, enter the code for your brand.
- For Samsung A TVs
While holding down the TV button, enter 0.
- 4 If the TV turns off, setup is complete.
Enter other codes of the same brand if the first code does not work.
- 5 To operate the TV, use the "TV Function Buttons" described on page 11.

TV Codes

CODE	BRAND	CODE	BRAND
0	SAMSUNG A	OPEN/CLOSE	MITSUBISHI
1	SHARP B	AUDIO	SAMSUNG B
2	SONY	SUB TITLE	SAMSUNG C
3	MAGNAVOX	DVD POWER	SHARP A
4	SANYO A	ANGLE	ZENITH
5	LG B	TOP MENU	LG C
6	RCA	MENU	DAEWOO
7	LG A	RETURN	SANYO B
8	TOSHIBA	REV SEARCH	EMERSON
9	HITACHI	REPEAT	SHARP C
SETUP	JVC	FWD SEARCH	SAMSUNG D
DISPLAY	PANASONIC A	BACK SKIP	PANASONIC B

NOTE

- The remote may not be able to control every model TV of the brands listed.
- Certain audio features of this product manufactured under a license from Desper Products, Inc. Spatializer® and circle-in-square device are trademarks owned by Desper Products, Inc.
- Manufactured under license from Dolby Laboratories. "Dolby" and the double-D symbol are trademarks of Dolby Laboratories. Confidential unpublished works. ©1992-1997 Dolby Laboratories Inc. All rights reserved.
- "DTS" and "DTS Digital Out" are trademarks of Digital Theater Systems, Inc.
- VM Labs Legal Notices:
Trademark: "NUON™" and "VLM" and "Virtual Light Machine™" are trademarks of VM Labs, Inc.

Copyright: NUON Mediaware, Copyright ©1995-2000, VM Labs, Inc. All rights reserved.

Patents: This product is covered by one or more claims of certain issued and pending U.S. Patents and patent applications of VM Labs, Inc. Reverse engineering and disassembly are prohibited.

- HDCD®, High Definition Compatible Digital® and Pacific Microsonics™ are either registered trademarks or trademarks of Pacific Microsonics, Inc. in the United States and/or other countries. HDCD system manufactured under license from Pacific Microsonics, Inc. This product is covered by one or more of the following: In the USA: 5,479,168, 5,638,074, 5,640,161, 5,808,574, 5,838,274, 5,854,600, 5,864,311, 5,872,531, and in Australia: 669114. Other patents pending.

Troubleshooting Guide

Before requesting service (troubleshooting)

Problem	Action	Page
No operations can be performed with remote.	<ul style="list-style-type: none"> • Check the batteries in the remote. May need replacing. • Operate the remote control at a distance of no more than 20 feet. • Remove batteries and hold down one or more buttons for several minutes to drain the microprocessor inside the remote to reset it. Reinstall batteries and try remote again. 	P6
Disc does not play.	<ul style="list-style-type: none"> • Ensure that the disc is installed with the label side facing up. • Check the region number of the DVD. • This player cannot play CD-ROMs, DVD-ROMs, CD-R, etc. Insert a DVD, a VIDEO-CD or a CD. 	P4
5.1 channel sound is not being reproduced.	<ul style="list-style-type: none"> • 5.1 channel sound is reproduced only when the following conditions are met : <ol style="list-style-type: none"> 1)The DVD player is connected with the proper amplifier 2)The disc is recorded with 5.1 channel sound. • Check whether the disc being played has the "Dolby 5.1 ch" mark on the outside. • Check if your audio system is connected and working properly. 	P9, 13
The  icon appears on screen.	<ul style="list-style-type: none"> • The features or action cannot be completed at this time because: <ol style="list-style-type: none"> 1. The DVD's software restricts it. 2. The DVD's software doesn't support the feature (e.g., angles). 3. The feature is not available at the moment. 4. You've requested a title or chapter number or search time that is out of range. 	P17, 19-27
Disc Menu doesn't appear.	<ul style="list-style-type: none"> • Check if the disc has a Menu. 	P25, 26
Playback mode differs from the Setup Menu selection.	<ul style="list-style-type: none"> • Some of the functions selected in the Setup Menu may not work properly if the disc is not encoded with the corresponding function. 	P16, 29-32
The screen ratio can't be changed.	<ul style="list-style-type: none"> • The Screen Ratio is fixed on your DVDs. 	P32
No audio.	<ul style="list-style-type: none"> • Make sure you have selected the correct Digital Output in the Audio Options Menu. 	P31
Forgot password	<ul style="list-style-type: none"> • Press power on from a cold start with no disc in the unit. Press the STOP and PLAY buttons simultaneously on the front panel for three seconds. "All setup value will be reset to factory settings. Your player will be shut off." will appear. Press the SETUP button on the remote control to select the Parental Mode. The Parental Mode is now unlocked as indicated on the display. Press the DOWN button to select Parental. Press ENTER and the Password Check display will appear. Enter the default password of "9999". You can now set your rating level and change your password to a new number. 	P30
Will not read disc or other error message.	<ul style="list-style-type: none"> • Turn the player off and unplug it to reset the DVD player. Wait approximately 2 minutes, plug the player back in and turn it on. 	
If you experience other problems.	<ul style="list-style-type: none"> • Go to the contents and find the section of the instruction book that contains the explanations regarding the current problem, and follow the procedure once again. • If the problem still cannot be solved, please contact your nearest authorized service center. 	

Specifications

General	Power Requirements	AC 120 V, 60 Hz
	Power Consumption	21 W
General	Weight	7.5 lbs
	Dimensions	W 16.9 in x D 11.0 in x H 3.5 in
General	Operating Temperature Range	+41°F to +95°F
	Operating Humidity Range	10 % to 75 %
Disc	DVD (DIGITAL VERSATILE DISC)	Reading Speed : 11.45 ft/sec Approx. Play Time (Single Sided, Single Layer Disc) : 135 min
	CD : 5" (COMPACT DISC)	Reading Speed : 3.9 to 4.6 ft/sec Maximum Play Time : 74 min
	CD : 3 1/2" (COMPACT DISC)	Reading Speed : 3.9 to 4.6 ft/sec Maximum Play Time : 20 min.
	VCD : 5"	Reading Speed : 3.9 to 4.6 ft/sec. Maximum Play Time : 74 min (Video + Audio)
Video Output	Composite Video	2 channel : 1.0 Vp-p (75 Ω load) Y : 1.0 Vp-p (75 Ω load)
	Component Video	Pr : 0.70 Vp-p (75 Ω load) Pb : 0.70 Vp-p (75 Ω load) Luminance Signal : 1.0 Vp-p (75 Ω load)
	S-VIDEO	Color Signal : 0.286 Vp-p (75 Ω load)
Audio Output	2 Channel	L(1/L), R(2/R)
	5.1 Channel	F/L, F/R, R/L, R/R, C/T, S/W
	Output Level	Analog : 2 Vrms (1 kHz) Digital : 1.15 Vp-p
	*Frequency Response	48 kHz Sampling : 4 Hz to 22 kHz 96 kHz Sampling : 4 Hz to 44 kHz
	*S/N Ratio	110 dB
	*Dynamic Range	92 dB
*Total Harmonic Distortion	0.003 % (In case of 1 KHz)	

*: Nominal specification

- Samsung Electronics Co., Ltd reserves the right to change the specifications without notice.
- Weight and dimensions are approximate.

READ THIS NOTICE BEFORE YOU OR YOUR CHILD USE ANY VIDEO GAME

A very small portion of the population have a condition which may cause them to experience epileptic seizures or have momentary loss of consciousness when viewing certain kinds of flashing lights or patterns that are commonly present in our daily environment. These persons may experience seizures while watching some kinds of television pictures or playing certain video games. Players who have not had any previous seizures may nonetheless have an undetected epileptic condition.

If you or anyone in your family has experienced symptoms linked to an epileptic condition (e.g. a seizure or loss of awareness), immediately consult your physician before using any video games.

We recommend that parents observe their children while they play video games. If you or your child experience any of the following symptoms: dizziness, altered vision, eye or muscle twitching, involuntary movements, loss of awareness, disorientation, or convulsions, DISCONTINUE USE IMMEDIATELY and consult your physician.

FOLLOW THESE PRECAUTIONS WHENEVER USING VIDEO GAMES:

- When using your NUON Interactive DVD player, do not sit or stand too close to the television screen. Play as far back from the screen as possible.
- Play video games on the smallest available television screen.
- Do not play if you are tired or need sleep.
- Always play in a well lit room.
- Be sure to take a 10 to 15 minute break every hour while playing.

Repetitive Strain Warning

Some people may experience fatigue or discomfort after playing for a long time. Regardless of how you feel, you should ALWAYS take a 10 to 15 minute break every hour while playing. If your hands or arms become tired or uncomfortable while playing, stop and rest. If you continue to experience soreness or discomfort during or after play, listen to the signals your body is giving you. Stop playing and consult a doctor. Failure to do so could result in long term injury.

If your hands, wrist or arms have been injured or strained in other activities, use of your system could aggravate the condition. Before playing, consult a doctor.

Motion Sickness

Samsung Extiva DVD players generate realistic images and 3-D simulations. While playing or watching certain video images, some people may experience dizziness, motion sickness or nausea. If you or your child experience any of these symptoms, discontinue use and play again later.

Projection Television Warning

DO NOT USE WITH A FRONT OR REAR PROJECTION TV

Do not use a front or rear projection television with your NUON Interactive DVD Player. Your projection television screen may be permanently damaged if video games with stationery scenes or patterns are played on your projection television. Similar damage may occur if you place a video game on hold or pause. If you use your projection television with NUON Interactive Software, neither VM Labs nor any of VM Labs' licensees will be liable for any damage. This situation is not caused by a defect in the DVD player or NUON games; other fixed or repetitive images may cause similar damage to a projection television. Please contact your TV manufacturer for further information.

Warranty (for USA users only)

LIMITED WARRANTY TO ORIGINAL PURCHASER

This SAMSUNG brand product, as supplied and distributed by SAMSUNG ELECTRONICS AMERICA, INC. (SAMSUNG) and delivered new, in the original carton to the original consumer purchaser, is warranted by SAMSUNG against manufacturing defects in materials and workmanship for the following limited warranty period:

One (1) Year Parts and Labor

This limited warranty begins on the original date of purchase, and is valid only on products purchased and used in the United States, and does not include transportation, installation, removal or reinstallation. Warranty repairs must be performed by SAMSUNG's authorized service center. To receive warranty service, the original dated bill of sale must be presented upon request as proof of purchase to SAMSUNG or SAMSUNG's authorized service center. Transportation to and from the service center is the responsibility of the purchaser.

SAMSUNG will repair or replace this product, at our option and at no charge with new or reconditioned parts, if found to be defective during the limited warranty period specified above. The product must be returned during the warranty period with transportation charges prepaid to SAMSUNG's designated service center. Prior to returning any product for warranty service, the purchaser must contact SAMSUNG for problem determination and service procedures. SAMSUNG does not warrant uninterrupted or error-free operation of the product. All replaced parts and products become the property of SAMSUNG and must be returned to SAMSUNG. Replacement parts and products assume the remaining original warranty, or ninety (90) days, whichever is longer.

This limited warranty covers manufacturing defects in materials and workmanship encountered in normal, noncommercial use of this product and shall not apply to the following, including, but not limited to: damage which occurs in shipment; applications and uses for which this product was not intended; failures or problems which are caused by products or equipment not supplied by SAMSUNG; accidents, misuse, abuse, neglect, misapplication, fire, water, lightning or other acts of nature; incorrect electrical line voltage, fluctuations or surges; damage caused by improper or faulty installation; improper connection with any peripheral; product alteration or modification; improper or unauthorized repair; cosmetic damage or exterior finish; product with altered serial numbers; failure to follow operating instructions, customer adjustments, maintenance and environmental instructions that are covered and prescribed in the instruction book; use of non-SAMSUNG or unauthorized parts, supplies, accessories or equipment which damage this product or result in service problems; failures or problems due to incompatibility with other equipment.

THERE ARE NO EXPRESS WARRANTIES OTHER THAN THOSE LISTED AND DESCRIBED ABOVE, AND NO WARRANTIES WHETHER EXPRESS OR IMPLIED, INCLUDING, BUT NOT LIMITED TO, ANY IMPLIED WARRANTIES OF MERCHANTABILITY OR FITNESS FOR A PARTICULAR PURPOSE, SHALL APPLY AFTER THE EXPRESS WARRANTY PERIODS STATED ABOVE, AND NO OTHER EXPRESS WARRANTY OR GUARANTY GIVEN BY ANY PERSON, FIRM OR CORPORATION WITH RESPECT TO THIS PRODUCT SHALL BE BINDING ON SAMSUNG. SAMSUNG SHALL NOT BE LIABLE FOR LOSS OF REVENUE OR PROFITS, FAILURE TO REALIZE SAVINGS OR OTHER BENEFITS, OR ANY OTHER SPECIAL, INCIDENTAL OR CONSEQUENTIAL DAMAGES CAUSED BY THE USE, MISUSE OR INABILITY TO USE THIS PRODUCT,

REGARDLESS OF THE LEGAL THEORY ON WHICH THE CLAIM IS BASED, AND EVEN IF SAMSUNG HAS BEEN ADVISED OF THE POSSIBILITY OF SUCH DAMAGES. NOR SHALL RECOVERY OF ANY KIND AGAINST SAMSUNG BE GREATER IN AMOUNT THAN THE PURCHASE PRICE OF THE PRODUCT SOLD BY SAMSUNG AND CAUSING THE ALLEGED DAMAGE. WITHOUT LIMITING THE FOREGOING, PURCHASER ASSUMES ALL RISK AND LIABILITY FOR LOSS, DAMAGE OR INJURY TO PURCHASER AND PURCHASER'S PROPERTY AND TO OTHERS AND THEIR PROPERTY ARISING OUT OF THE USE, MISUSE OR INABILITY TO USE THIS PRODUCT SOLD BY SAMSUNG NOT CAUSED DIRECTLY BY THE NEGLIGENCE OF SAMSUNG. THIS LIMITED WARRANTY SHALL NOT EXTEND TO ANYONE OTHER THAN THE ORIGINAL PURCHASER OF THIS PRODUCT, IS NONTRANSFERABLE AND STATES YOUR EXCLUSIVE REMEDY.

Some states do not allow limitations on how long an implied warranty lasts, or the exclusion or limitation of incidental or consequential damages, so the above limitations or exclusions may not apply to you. This warranty gives you specific legal rights, and you may also have other rights which vary from state to state.

To obtain warranty service, please contact SAMSUNG at:

**SAMSUNG ELECTRONICS AMERICA, INC. -
CONSUMER ELECTRONICS CUSTOMER SERVICE
1 SAMSUNG PLACE, LEDGEWOOD, NJ 07852
Tel: 973-691-6200, Fax: 973-691-6201
1-800-SAMSUNG (1-800-726-7864)
www.sosimple.com**

Warranty (for Canada users only)

LIMITED WARRANTY TO ORIGINAL PURCHASER

Samsung Electronics Canada Inc.(SECA), warrants that this product is free from defective material and workmanship.

SECA further warrants that if this product falls to operate properly within the specified warranty period and the failure is due to improper workmanship or defective materials, SECA will repair or replace the product at its option.

All warranty repairs must be performed by a SECA Authorized Service Center. (The name and address of the location nearest you can be obtained by calling toll free: 1- 800- SAM-SUNG)

LABOR
One year (Carry-in)

PARTS
One year

On carry-in models, transportation to and from the service center is the customer's responsibility.

The original dated sales receipt must be retained by the customer and is the only acceptable proof of purchase. It must be presented to the authorized service center at the time service is requested.

EXCLUSIONS (WHAT IS NOT COVERED)

This warranty does not cover damage due to accident, fire, flood and/ or other acts of God; misuse, incorrect line voltage, improper installation, improper or unauthorized repairs, commercial use or damage that occurs in shipping. Exterior and interior finish, lamps, glass are not covered under this warranty. Customer adjustments which are explained in the instruction manual are not covered under the terms of this warranty. This warranty will automatically be voided for any unit found with a missing or altered serial number. This warranty is valid only on products purchased and used in Canada.